

# JVC

## DIGITAL VIDEO CAMERA

# GR-DX300 GR-DX95 GR-DX75

Please visit our Homepage on the World Wide Web for Digital Video Camera:

<http://www.jvc-victor.co.jp/english/cyber/>

For Accessories:

<http://www.jvc-victor.co.jp/english/accessory/>

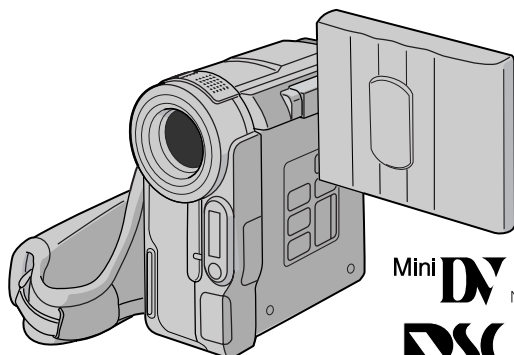

Mini DV NTSC  
DIGITAL  
STILL CAMERA

## INSTRUCTIONS

ENGLISH

## CONTENTS

AUTOMATIC DEMONSTRATION 6

GETTING STARTED 7 - 11

TAPE RECORDING & PLAYBACK 12 - 16

MEMORY CARD RECORDING & PLAYBACK 17 - 24

ADVANCED FEATURES 25 - 44

REFERENCES 45 - 59

### For Customer Use:

Enter below the Model No. and Serial No. which is located on the bottom of the camcorder. Retain this information for future reference.

Model No. \_\_\_\_\_

Serial No. \_\_\_\_\_

LYT1140-001B

EN

# CONTENTS

<b>SAFETY PRECAUTIONS</b> .....	3
<b>SOME DO'S AND DON'TS ON THE SAFE USE OF EQUIPMENT</b> .....	4
<b>PROVIDED ACCESSORIES</b> .....	5
<b>HOW TO ATTACH THE LENS CAP</b> .....	5
<b>HOW TO ATTACH THE CORE FILTER</b> .....	6
<b>AUTOMATIC DEMONSTRATION</b> .....	6

## GETTING STARTED

<b>Power</b> .....	7 – 8
<b>Grip Adjustment</b> .....	8
<b>Viewfinder Adjustment</b> .....	8
<b>Tripod Mounting</b> .....	9
<b>Loading/Unloading A Cassette</b> .....	9 – 10
<b>Date/Time Settings</b> .....	10
<b>Recording Mode Setting</b> .....	10
<b>Loading A Memory Card</b> .....	11
<b>Picture Quality/Image Size Setting</b> .....	11

## TAPE RECORDING & PLAYBACK

<b>TAPE RECORDING</b> .....	12 – 14
Basic Recording .....	12 – 13
Zooming .....	13
Time Code .....	14
<b>TAPE PLAYBACK</b> .....	14 – 16
Normal Playback .....	14 – 15
Blank Search .....	15
Connections .....	16

## MEMORY CARD RECORDING & PLAYBACK

<b>MEMORY CARD RECORDING</b> .....	17 – 18
Basic Shooting (Snapshot) .....	17 – 18
<b>MEMORY CARD PLAYBACK</b> .....	18 – 19
Normal Playback .....	18
Auto Playback .....	19
Index Playback .....	19
Viewing File Information .....	19
Removing On-Screen Display .....	19
<b>ADVANCED FEATURES</b> .....	20 – 24
Protecting Files .....	20
Deleting Files .....	20
<b>NAVIGATION Function</b> .....	21 – 22
E-Mail Clip Recording .....	22
Dubbing Still Images Recorded On A Tape To A Memory Card .....	23

Setting Print Information (DPOF Setting) .....	23 – 24
Making A New Folder .....	24
Initializing A Memory Card .....	24

## ADVANCED FEATURES

<b>FOR RECORDING</b> .....	25 – 31
Snapshot Flash .....	25
Flash Brightness Adjustment .....	25
Self-Timer (GR-DX300 only) .....	26
5-Second Recording (GR-DX300 only) .....	26
Night-Alive .....	27
Program AE With Special Effects .....	27
Fade/Wipe Effects .....	28
Snapshot (For Tape Recording) .....	29
Auto Focus .....	29
Manual Focus .....	30
Exposure Control .....	30
Iris Lock .....	31
White Balance Adjustment .....	31
Manual White Balance Operation .....	31
<b>USING MENUS FOR DETAILED ADJUSTMENT</b> .....	32 – 36
For Recording Menu .....	32 – 35
For Playback Menu .....	35 – 36

<b>DUBBING</b> .....	37 – 38
Dubbing To Or From A VCR .....	37
Dubbing To Or From A Video Unit Equipped With A DV Connector (Digital Dubbing) .....	38

<b>USING THE REMOTE CONTROL UNIT</b> .....	39 – 43
Slow-Motion Playback .....	39
Frame-By-Frame Playback .....	39
Playback Special Effects .....	39
Playback Zoom .....	39
Audio Dubbing .....	40
Insert Editing .....	40
Random Assemble Editing [R.A.Edit] .....	41 – 43
For More Accurate Editing .....	43

<b>SYSTEM CONNECTIONS</b> .....	44
Connection To A Personal Computer .....	44

## REFERENCES

<b>TROUBLESHOOTING</b> .....	45 – 47
<b>CAUTIONS</b> .....	48 – 50
<b>SPECIFICATIONS</b> .....	51
<b>INDEX</b> .....	52 – 57
Controls, Connectors And Indicators .....	52 – 53
LCD Monitor/Viewfinder Indications .....	54 – 57
<b>TERMS</b> .....	58 – 59

Refer to the diagrams on page 52 and 54 while reading the instruction manual as all the controls, connectors, indicators and indications are numbered on the diagrams and those corresponding numbers are used throughout this manual unless specified.

## Dear Customer,

Thank you for purchasing this digital video camera. Before use, please read "SAFETY PRECAUTIONS" and "IMPORTANT PRODUCT SAFETY INSTRUCTIONS" (☞ pgs. 3 and 4) to ensure safe use of this product.

## SAFETY PRECAUTIONS



**CAUTION**  
RISK OF ELECTRIC SHOCK  
DO NOT OPEN



**CAUTION:** TO REDUCE THE RISK OF ELECTRIC SHOCK, DO NOT REMOVE COVER (OR BACK). NO USER-SERVICEABLE PARTS INSIDE. REFER SERVICING TO QUALIFIED SERVICE PERSONNEL.

### WARNING:

**TO REDUCE THE RISK OF FIRE OR ELECTRIC SHOCK, DO NOT EXPOSE THIS APPARATUS TO RAIN OR MOISTURE.**



The lightning flash with arrowhead symbol, within an equilateral triangle, is intended to alert the user to the presence of uninsulated "dangerous voltage" within the product's enclosure that may be of sufficient magnitude to constitute a risk of electric shock to persons.



The exclamation point within an equilateral triangle is intended to alert the user to the presence of important operating and maintenance (servicing) instructions in the literature accompanying the appliance.

### NOTES:

- The rating plate (serial number plate) and safety caution are on the bottom and/or the back of the main unit.
- The rating information and safety caution of the AC Adapter are on its upper and lower sides.

### CAUTIONS:

- This camcorder is designed to be used with NTSC-type color television signals. It cannot be used for playback with a television of a different standard. However, live recording and LCD monitor/viewfinder playback are possible anywhere.
- Use the JVC BN-V107U/V114U battery packs and, to recharge them or to supply power to the camcorder from an AC outlet, use the provided multi-voltage AC Adapter. (An appropriate conversion adapter may be necessary to accommodate different designs of AC outlets in different countries.)

When the equipment is installed in a cabinet or on a shelf, make sure that it has sufficient space on all sides to allow for ventilation (10 cm (3-15/16") or more on both sides, on top and at the rear).

Do not block the ventilation holes.

(If the ventilation holes are blocked by a newspaper, or cloth etc. the heat may not be able to get out.)

No naked flame sources, such as lighted candles, should be placed on the apparatus.

When discarding batteries, environmental problems must be considered and the local rules or laws governing the disposal of these batteries must be followed strictly.

The apparatus shall not be exposed to dripping or splashing.

Do not use this equipment in a bathroom or places with water.

Also do not place any containers filled with water or liquids (such as cosmetics or medicines, flower vases, potted plants, cups etc.) on top of this unit.

(If water or liquid is allowed to enter this equipment, fire or electric shock may be caused.)

This product has a fluorescent lamp that contains a small amount of mercury. Disposal of these materials may be regulated in your community due to environmental considerations.

For disposal or recycling information please contact your local authorities, or the Electronics Industries Alliance:

<<http://www.eiae.org>>

Do not point the lens or the viewfinder directly into the sun. This can cause eye injuries, as well as lead to the malfunctioning of internal circuitry. There is also a risk of fire or electric shock.

### CAUTION!

The following notes concern possible physical damage to the camcorder and to the user.

When carrying, be sure to always securely attach and use the provided shoulder strap. Carrying or holding the camcorder by the viewfinder and/or the LCD monitor can result in dropping the unit, or in a malfunction.

Take care not to get your finger caught in the cassette holder cover. Do not let children operate the camcorder, as they are particularly susceptible to this type of injury.

Do not use a tripod on unsteady or unlevel surfaces. It could tip over, causing serious damage to the camcorder.

### CAUTION!

Connecting cables (Audio/Video, S-Video, etc.) to the camcorder and leaving the unit on top of the TV is not recommended, as tripping on the cables will cause the camcorder to fall, resulting in damage.

## IMPORTANT PRODUCT SAFETY INSTRUCTIONS

- (1) Read these instructions.
- (2) Keep these instructions.
- (3) Heed all warnings.
- (4) Follow all instructions.
- (5) Do not use this apparatus near water.
- (6) Clean only with dry cloth.
- (7) Do not block any ventilation openings. Install in accordance with the manufacturer's instructions.
- (8) Do not install near any heat sources such as radiators, heat registers, stoves, or other apparatus (including amplifiers) that produce heat.
- (9) Only use attachments/accessories specified by the manufacturer.
- (10) Use only with the cart, stand, tripod, bracket, or table specified by the manufacturer, or sold with the apparatus. When a cart is used, use caution when moving the cart/apparatus combination to avoid injury from tip-over.
- (11) Unplug this apparatus during lightning storms or when unused for long periods of time.
- (12) Refer all servicing to qualified service personnel. Servicing is required when the apparatus has been damaged in any way, such as power-supply cord or plug is damaged, liquid has been spilled or objects have fallen into the apparatus, the apparatus has been exposed to rain or moisture, does not operate normally, or has been dropped.



Mini **DV** NTSC



**MultiMediaCard**

- This camcorder is designed exclusively for the digital video cassette, SD Memory Card and MultiMediaCard. Only cassettes marked "Mini DV" and memory cards\* marked "SD" or "MultiMediaCard" can be used with this unit.

### Before recording an important scene . . .

..... make sure you only use cassettes with the Mini DV mark **Mini DV**.

..... make sure you only use memory cards with the mark **SD** or **MultiMediaCard**.

..... remember that this camcorder is not compatible with other digital video formats.

..... remember that this camcorder is intended for private consumer use only. Any commercial use without proper permission is prohibited. (Even if you record an event such as a show, performance or exhibition for personal enjoyment, it is strongly recommended that you obtain permission beforehand.)

## PROVIDED ACCESSORIES

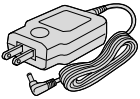

or

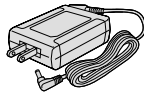

AC Adapter AP-V11U or AP-V13U

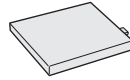

Battery Pack BN-V107U-S



S-Video/Audio/  
Video/Editing Cable

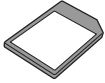

Memory Card 8 MB  
(GR-DX300/DX95 only)  
(Already inserted in the  
camcorder)

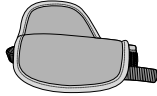

Grip Belt  
(Already attached  
to the camcorder)



Lens Cap  
(See below for  
attachment)



Editing  
Extension Cable



USB Cable



AAA (R03) Battery x 2  
(for remote control unit)

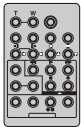

Remote  
Control Unit  
RM-V717U

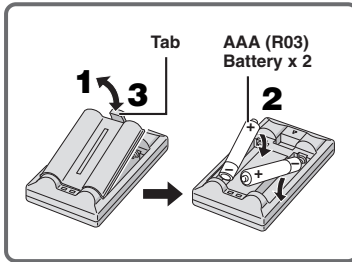

Core Filter  
(for provided USB  
Cable pg. 6 for  
attachment)



Core Filter x 2  
(for provided S-Video/Audio/  
Video/Editing Cable and  
AC Adapter's cord pg. 6  
for attachment)



CD-ROM

### NOTES:

- In order to maintain optimum performance of the camcorder, provided cables may be equipped with one or more core filter. If a cable has only one core filter, the end that is closest to the filter should be connected to the camcorder.
- Make sure to use the provided cables for connections. Do not use any other cables.

## HOW TO ATTACH THE LENS CAP

To protect the lens, attach the provided lens cap to the camcorder as shown in the illustration.

### NOTE:

To confirm the lens cap is on correctly make sure the cap is flush to the camera.

**1**

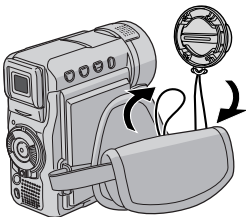

**2**

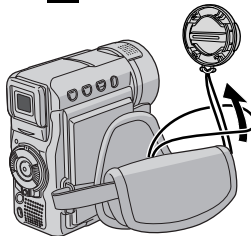

**3**

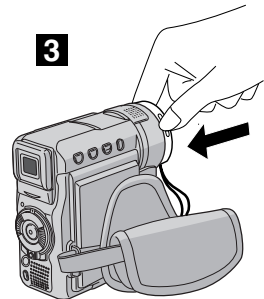

## HOW TO ATTACH THE CORE FILTER

Attach the Core Filter(s) to the provided AC Adapter's cord, S-Video/Audio/Video/Editing cable and USB cable. The Core Filter reduces interference.

- 1** Release the stoppers on both ends of the Core Filter.



- 2** 1) Run the cable through the Core Filter, leaving approx. 3 cm (1-3/16") of cable between the cable plug and the Core Filter.  
If using the AC Adapter's cord or USB cable, be sure to wind the cable once around the outside of the Core Filter as shown in the illustration. Wind the cable so that it is not slack.

**NOTE:** Take care not to damage the cable.

- 2) Close the Core Filter until it clicks shut.

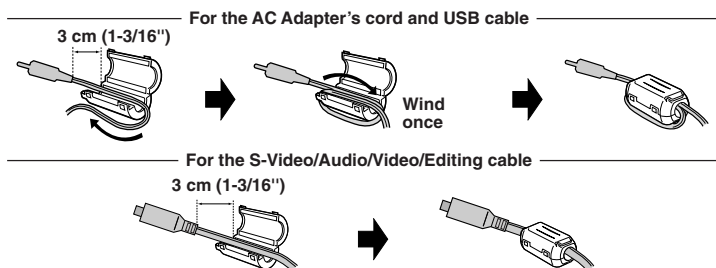

- When connecting cables, attach the end with the Core Filter to the camcorder.

## AUTOMATIC DEMONSTRATION

### Automatic Demonstration takes place when "DEMO MODE" is set to "ON" (factory-preset).

- Automatic Demonstration starts when there is no operation for about 3 minutes after the Power Switch **12** is set to "A" or "M" and no cassette is in the camcorder.
- Performing any operation during the demonstration stops the demonstration temporarily. If no operation is performed for more than 3 minutes after that, the demonstration will resume.
- "DEMO MODE" remains "ON" even if the camcorder power is turned off.
- To cancel Automatic Demonstration:
  1. Set the Power Switch **12** to "M" while pressing down the Lock Button **14** located on the switch and press **MENU** **4**. The Menu Screen appears.
  2. Press + or - **5** to select "SYSTEM" and press **SELECT/SET** **3**.
  3. Press + or - **5** to select "DEMO MODE" and press **SELECT/SET** **3**. The Sub Menu appears.
  4. Press + or - **5** to select "OFF" and press **SELECT/SET** **3**.
  5. Press + or - **5** to select "RETURN", and press **SELECT/SET** **3** twice. The normal screen appears.

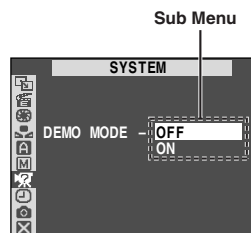
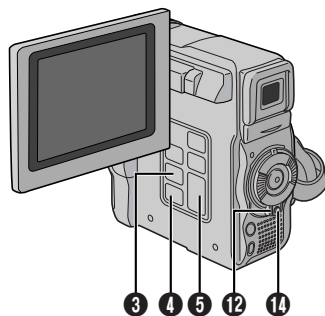

### NOTE:

If you do not detach the Lens Cap, you cannot see the actual changes of the Automatic Demonstration activated on the LCD monitor or viewfinder.

## CHARGING THE BATTERY PACK

**1** Insert the terminal end of the battery pack into the battery pack mount **26**, then firmly push the end of the battery pack in the direction of the arrow until it locks into place as shown in the illustration.

**2** Set the Power Switch **12** to "OFF". Connect the AC Adapter to the camcorder.

**3** Plug the AC Adapter into an AC outlet. The Power lamp **10** on the camcorder blinks to indicate charging has started.

**4** When the Power lamp **10** goes off, charging is finished. Unplug the AC Adapter from the AC outlet. Disconnect the AC Adapter from the camcorder.

### To Detach The Battery Pack:

While sliding **BATT. RELEASE** **32** up, detach it.

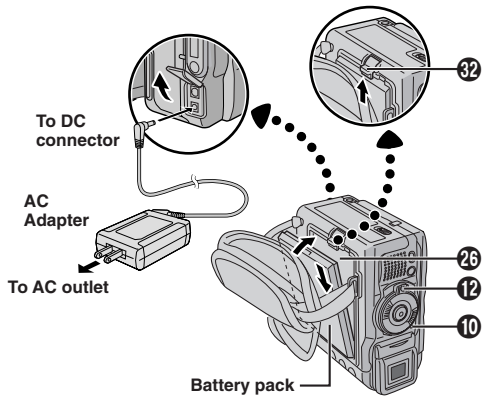

Battery pack	Charging time
BN-V107U	approx. 1 hr. 30 min.
BN-V114U (optional)	approx. 3 hrs.

Charging times are for a fully discharged battery pack.

## USING THE BATTERY PACK

Perform step **1** of "CHARGING THE BATTERY PACK".

### Maximum continuous recording time

Battery pack	LCD monitor on	Viewfinder on
BN-V107U	1 hr. 5 min.	1 hr. 25 min.
BN-V114U (optional)	2 hrs. 10 min.	2 hrs. 55 min.
BN-V840U (optional)	5 hrs. 50 min.	7 hrs. 50 min.
BN-V856U (optional)	8 hrs. 20 min.	11 hrs. 10 min.

## USING AC POWER

Connect the AC Adapter to the camcorder as shown in the following illustration.

- The provided AC Adapter features automatic voltage selection in the AC range from 110 V to 240 V.

## ATTENTION

Before detaching the power source, make sure that the camcorder's power is turned off. Failure to do so can result in a camcorder malfunction.

## INFORMATION

The extended-use battery pack kit is a set composed of a battery pack and AC Power Adapter/Charger:

- VU-V840 KIT : BN-V840U battery pack & AA-V15U AC Power Adapter/Charger
- VU-V856 KIT : BN-V856U battery pack & AA-V80U AC Power Adapter/Charger

Read the kit's instruction manual before using. Also, by using the optional JVC VC-VBN856U DC Cord, it will be possible to connect BN-V840U or BN-V856U battery packs to the camcorder and supply power directly to the camcorder.

### NOTES:

- If the protective cap is attached to the battery pack, remove it first.
- During charging, the camcorder cannot be operated.
- Charging is not possible if the wrong type of battery is used.
- When charging the battery pack for the first time or after a long storage period, the Power lamp **10** may not light. Remove the battery pack from the camcorder, then try charging again.
- If a fully-charged battery's operation time remains extremely short, the battery is worn out. Please purchase a new one.
- Recording time is reduced significantly when Zoom or Record-Standby mode is engaged repeatedly or the LCD monitor is used repeatedly.
- Before extended use, it is recommended that you prepare enough battery packs to cover 3 times the planned shooting time.

Continued on next page.

- Since the AC Adapter processes electricity internally, it becomes warm during use. Be sure to use it only in well-ventilated areas.
- The following operation stops charging:
  - Set the Power Switch 12 to "PLAY", "A" or "M".
  - Disconnect the AC Adapter from the camcorder.
  - Unplug the AC Adapter from the AC outlet.
  - Detach the battery from the camcorder.
- This camcorder will be automatically turned off if its power is supplied from the AC adapter and about 5 minutes pass since it has entered into the recording standby mode with a cassette inserted. If, under those conditions, the battery is attached to the camcorder, its charging will start.
- Using the optional AA-V100U AC Power Adapter/Charger, you can charge the BN-V107U/V114U battery pack without the camcorder. However, it cannot be used as an AC adapter.
- To avoid interference with reception, do not use the AC Adapter near a radio.
- Perform charging where the temperature is between 10°C and 35°C (50°F and 95°F). 20°C to 25°C (68°F to 77°F) is the ideal temperature range for charging. If the environment is too cold, charging may be incomplete.
- Charging time varies according to the ambient temperature and the status of the battery pack.

## About Batteries

**DANGER!** Do not attempt to take the batteries apart, or expose them to flame or excessive heat, as it may cause a fire or explosion.

**WARNING!** Do not allow the battery or its terminals to come in contact with metals, as this can result in a short circuit and possibly start a fire.

### The Benefits Of Lithium-Ion Batteries

Lithium-ion battery packs are small but have a large power capacity. However, when one is exposed to cold temperatures (below 10°C/50°F), its usage time becomes shorter and it may cease to function. If this happens, place the battery pack in your pocket or other warm, protected place for a short time, then re-attach it to the camcorder. As long as the battery pack itself is not cold, it should not affect performance.

(If you're using a heating pad, make sure the battery pack does not come in direct contact with it.)

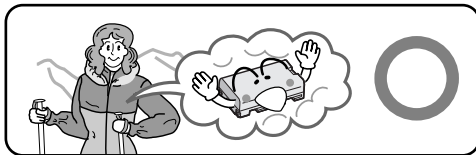

Lithium-ion is vulnerable in colder temperatures.

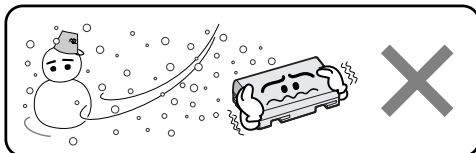

## Grip Adjustment

- 1 Separate the Velcro strip.
  - 2 Pass your right hand through the loop and grasp the grip.
  - 3 Adjust your thumb and fingers through the grip, to easily operate the Recording Start/Stop button 11 and Power Switch 12 and Power Zoom (SHUTTLE SEARCH) Ring 13. Be sure to fasten the Velcro strip to your preference.
- When holding the camcorder, make sure not to block the microphone and flash sensor with your fingers.

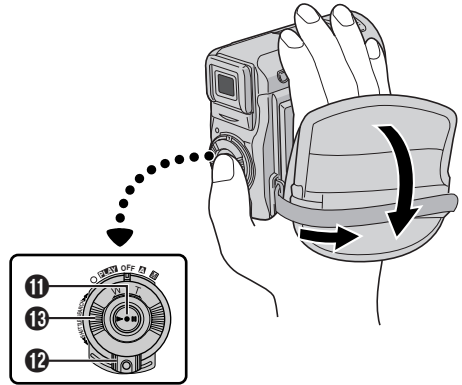

## Viewfinder Adjustment

- 1 Set the Power Switch 12 to "A" or "M" while pressing down the Lock Button 14 located on the switch.
- 2 Pull out the viewfinder fully and adjust it manually for best viewability.
- 3 Slide the Diopter Adjustment Control 29 until the indications in the viewfinder are clearly focused.

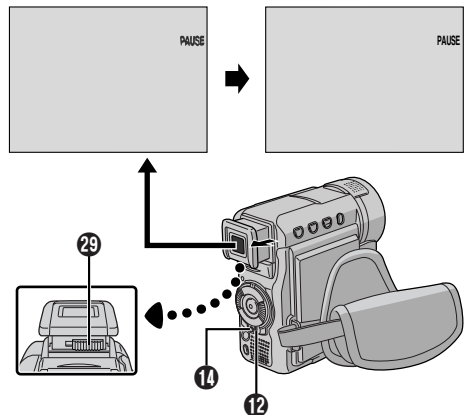



## Tripod Mounting

### CAUTION

When attaching the camcorder to a tripod, extend its legs to stabilize the camcorder. It is not advised to use small sized tripods. This may cause damage to the unit by falling over.

**1** To attach the camcorder to a tripod, align the screw to the mounting socket **30** on the camcorder. Then tighten the screw clockwise. Some tripods are not equipped with studs.

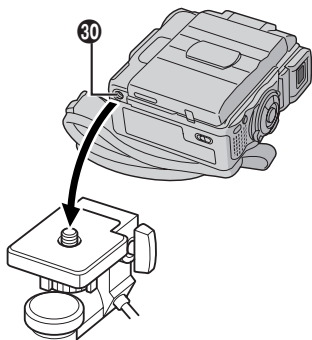

## Loading/Unloading A Cassette

The camcorder needs to be powered up to load or eject a cassette.

**1** Slide and hold **OPEN/EJECT** **38** in the direction of the arrow then pull the cassette holder cover open until it locks. The cassette holder opens automatically.

• Do not touch internal components.

**2** Insert or remove a tape and press "PUSH HERE" to close the cassette holder.

• Once the cassette holder is closed, it recedes automatically. Wait until it recedes completely before closing the cassette holder cover.

• When the battery's charge is low, you may not be able to close the cassette holder cover. Do not apply force. Replace the battery with a fully charged one before continuing.

**3** Close the cassette holder cover firmly until it locks into place.

### To Protect Valuable Recordings:

Slide the erase protection tab on the back of the tape in the direction of "SAVE". This prevents the tape from being recorded over. To record on this tape, slide the tab back to "REC" before loading it.

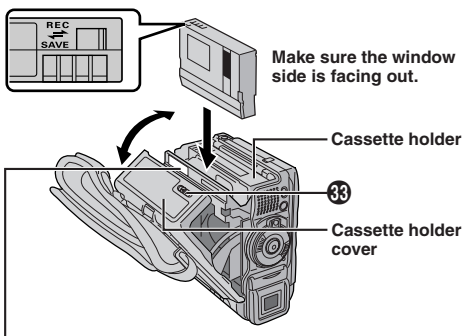

### PUSH HERE

Be sure to press only the section labeled "PUSH HERE" to close the cassette holder; touching other parts may cause your finger to get caught in the cassette holder, resulting in injury or product damage.

### Approximate recording time

Tape	Recording mode	
	SP	LP
30 min.	30 min.	45 min.
60 min.	60 min.	90 min.
80 min.	80 min.	120 min.

### NOTES:

- The cassette holder cannot be opened unless a power supply is attached.

Continued on next page.

- It takes a few seconds for the cassette holder to open. Do not apply force.
- There may be a delay after you open the cassette holder cover until the cassette holder opens. Do not use force.
- If you wait a few seconds and the cassette holder does not open, close the cassette holder cover and try again. If the cassette holder still does not open, turn the camcorder off then on again.
- If the tape does not load properly, open the cassette holder cover fully and remove the cassette. A few minutes later, insert it again.
- When the camcorder is suddenly moved from a cold place to a warm environment, wait a short time before opening the cassette holder cover.
- Once the cassette holder is closed, it recedes automatically. Wait until it recedes completely before closing the cassette holder cover.
- Closing the cassette holder cover before the cassette holder comes out may cause damage to the camcorder.
- Even when the camcorder is switched off, a cassette can be loaded or unloaded. After the cassette holder is closed with the camcorder switched off, however, it may not recede. It is recommended to turn the power on before loading or unloading.
- When resuming recording, once you open the cassette holder cover a blank portion will be recorded on the tape or a previously recorded scene will be erased (recorded over) regardless of whether the cassette holder came out or not. See page 14 for information about recording from the middle of a tape.

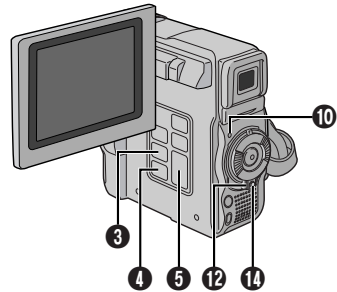
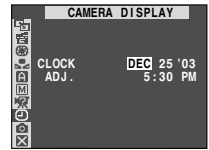
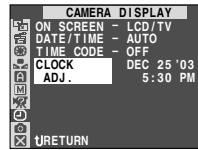

## Date/Time Settings

The date/time is recorded onto the tape at all times, but its display can be turned on or off during playback (ⓘ pg. 34).

- 1** Set the Power Switch **12** to “**M**” while pressing down the Lock Button **14** located on the switch, and open the LCD monitor fully or pull out the viewfinder fully. The Power lamp **10** lights and the camcorder is turned on.
- 2** Press **MENU** **4** to access the Menu Screen.
- 3** Press + or - **5** to select “**A** (CAMERA DISPLAY)” and press **SELECT/SET** **3**.
- 4** Press + or - **5** to select “**CLOCK ADJ.**”. Press **SELECT/SET** **3** and “month” is highlighted. Press + or - **5** to input the month. Press **SELECT/SET** **3**. Repeat to input the day, year, hour and minute. Press + or - **5** to select “**RETURN**”, and press **SELECT/SET** **3** twice. The Menu Screen closes.

### NOTES:

- Even if you select “**CLOCK ADJ.**”, if the parameter is not highlighted the camcorder’s internal clock continues to operate. Once you move the highlight bar to the first date/time parameter (month), the clock stops. When you finish setting the minute and press **SELECT/SET** **3**, the date and time begin operation from the date and time you just set.
- ⓘ pg. 49, “Built-in Clock’s Rechargeable Lithium Battery”.

## Recording Mode Setting

Set the tape recording mode depending on your preference.

- 1** Set the Power Switch **12** to “**M**” while pressing down the Lock Button **14** located on the switch, and open the LCD monitor fully or pull out the viewfinder fully. The Power lamp **10** lights and the camcorder is turned on.
  - 2** Press **MENU** **4**. The Menu Screen appears.
  - 3** Press + or - **5** to select “**A** (CAMERA)” and press **SELECT/SET** **3**.
  - 4** Press + or - **5** to select “**REC MODE**” and press **SELECT/SET** **3**. The Sub Menu appears. Select “**SP**” or “**LP**” by pressing + or - **5** and press **SELECT/SET** **3**. Press + or - **5** to select “**RETURN**”, and press **SELECT/SET** **3** twice. The Menu Screen closes.
- Audio Dubbing and Insert Editing (ⓘ pg. 40) are possible on tapes recorded in the SP mode.
  - “**LP**” (Long Play) is more economical, providing 1.5 times the recording time.

### NOTES:

- If the recording mode is switched during recording, the playback picture will be blurred at the switching point.
- It is recommended that tapes recorded in the LP mode on this camcorder be played back on this camcorder.
- During playback of a tape recorded on another camcorder, blocks of noise may appear or there may be momentary pauses in the sound.

## Loading A Memory Card

The provided memory card is already inserted in the camcorder when you receive the camcorder.

- 1 Make sure the camcorder's power is off.
- 2 Open the card cover (MEMORY CARD) ⑧.
- 3 Insert the memory card clipped edge first.
  - Do not touch the terminal on the reverse side of the label.
- 4 Close the card cover ⑧.

### To Unload A Memory Card:

In step 3 push the memory card into the camcorder, which releases the memory card. Pull it out and close the card cover ⑧.

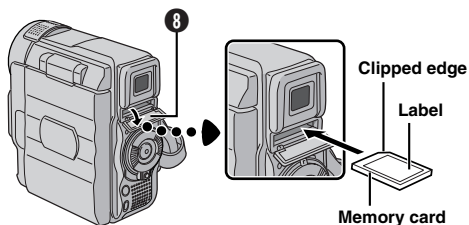

### NOTES:

- Be sure to use only SD Memory Cards marked "SD" or MultiMediaCards marked "MultiMediaCard".
- Some brands of memory cards are not compatible with this camcorder. Before purchasing a memory card, consult its manufacturer or dealer.
- Before using a new memory card, it is necessary to FORMAT the card. pg. 24.

## ATTENTION

Do not insert/remove the memory card while the camcorder is turned on, as this may cause the memory card to be corrupted or cause the camcorder to become unable to recognize whether or not the card is installed.

## Picture Quality/Image Size Setting

The Picture Quality/Image Size can be selected to best match your needs. Refer to the chart on page 18 for your selection.

- 1 Set the VIDEO/MEMORY Switch 25 to "MEMORY", then set the Power Switch 12 to "M" while pressing down the Lock Button 14 located on the switch. The Power lamp 10 lights and the camcorder turns on.
- 2 Press MENU 4. The Menu Screen appears.
- 3 Press + or - 5 to select "DSC" and press SELECT/SET 3.
- 4 Press + or - 5 to select "QUALITY" and press SELECT/SET 3. The Sub Menu appears. Press + or - 5 to select the desired mode and press SELECT/SET 3.
- 5 Press + or - 5 to select "IMAGE SIZE" and press SELECT/SET 3. The Sub Menu appears. Press + or - 5 to select the desired mode and press SELECT/SET 3.
- 6 Press + or - 5 to select "RETURN", and press SELECT/SET 3 twice. The Menu Screen closes.

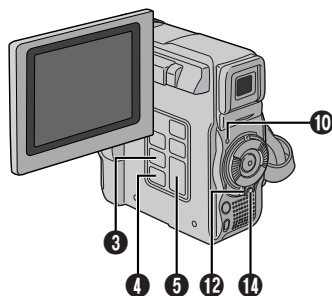
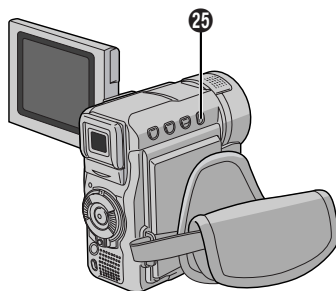

### Display



## Basic Recording

Perform the procedures listed below before continuing.

- Power (☞ pg. 7)
- Grip Adjustment (☞ pg. 8)
- Viewfinder Adjustment (☞ pg. 8)
- Load A Cassette (☞ pg. 9)
- Recording Mode Setting (☞ pg. 10)

**1** Remove the lens cap.

Pull on bottom end **31** of LCD monitor to open and set the **VIDEO/MEMORY** Switch **25** to "VIDEO".

**2** Set the Power Switch **12** to "A" or "M" while pressing down the Lock Button **11** located on the switch.

**Shooting while using the LCD monitor:** Open the LCD monitor fully.

- Lift up the LCD monitor fully, then rotate it.

**Shooting while using the viewfinder:** Pull out the viewfinder fully.

- The Power lamp **10** lights and the camcorder enters the Record-Standby mode. "PAUSE" ■ is displayed.
- The image will not appear simultaneously on the LCD monitor and the viewfinder. See "PRIORITY" in the SYSTEM Menu (☞ pg. 34).

**3** Press the Recording Start/Stop Button **11**. "▶REC" ■, ■ appears and the tally lamp **16** lights while recording is in progress.

- To Stop Recording, press the Recording Start/Stop Button **11**. The camcorder re-enters the Record-Standby mode.

### To Adjust The Brightness Of The Display

- ..... press **MONITOR BRIGHT +** or **-** **5** until the bright level indicator ■ on the display moves and the appropriate brightness is reached.
- It is also possible to adjust the brightness of the viewfinder. Pull out the viewfinder, set "PRIORITY" in the SYSTEM Menu to "FINDER" (☞ pg. 34) and adjust as described above.

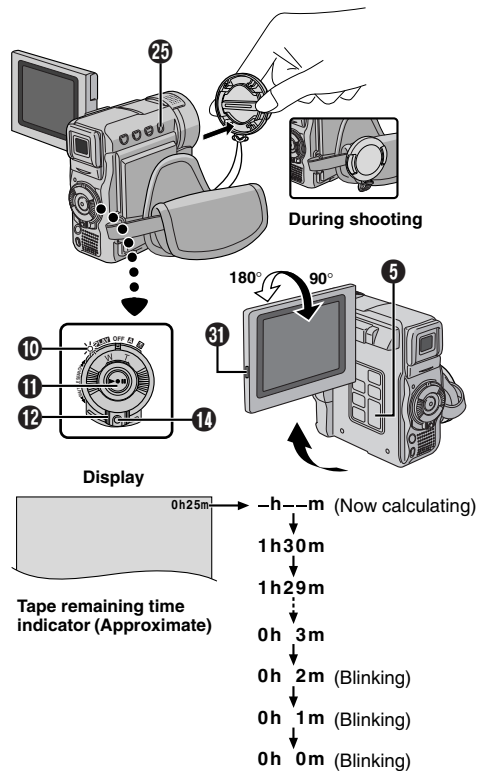

### NOTES:

- If the Record-Standby mode continues for 5 minutes, the camcorder's power shuts off automatically. To turn the camcorder on again, push back and pull out the viewfinder again or close and re-open the LCD monitor.
- When a blank portion is left between recorded scenes on the tape, the time code is interrupted and errors may occur when editing the tape. To avoid this, refer to "RECORDING FROM THE MIDDLE OF A TAPE" (☞ pg. 14).
- **To turn the tally lamp **16** or beep sounds off,** ☞ pg. 34.
- When you use the LCD monitor outdoors in direct sunlight, the LCD monitor may be difficult to see. If this happens, use the viewfinder instead.
- Black spots or bright spots of light (red, green or blue) may appear constantly on the LCD monitor or the viewfinder (☞ pg. 47).
- When the Recording Start/Stop button **11** is pressed, it may take a few seconds before actual recording starts. "▶REC" ■ starts rotating when the camcorder actually starts recording.
- The time required to calculate and display the remaining tape length, and the accuracy of the calculation, may vary according to the type of tape used.
- "TAPE END" appears when the tape reaches its end, and the power goes off automatically if left in this condition for 5 minutes. "TAPE END" also appears when a cassette at its end is loaded.

Refer to the diagrams on page 52 and 54 for the controls, indications, indicators and connectors mentioned.

## Journalistic Shooting

In some situations, different shooting angles may provide more dramatic results. Hold the camcorder in the desired position and tilt the LCD monitor in the most convenient direction. It can rotate 270° (90° downward, 180° upward).

## Self-Recording

You can shoot yourself while viewing your own image in the LCD monitor. Open the LCD monitor and tilt it upward 180° so that it faces forward, then point the lens toward yourself and start recording.

## Operation Mode

Choose the appropriate operation mode according to your preference using the Power Switch **12** and **VIDEO/MEMORY** Switch **25**.

Power Switch Position
<b>M</b> :
Allows you to set various recording functions using the Menus. If you want more creative capabilities than Full Auto recording, try this mode.
<b>A (Full Auto)</b> :
Allows you to record using NO special effects or manual adjustments. Suitable for standard recording.
<b>OFF</b> :
Allows you to switch off the camcorder.
<b>PLAY</b> :
<ul style="list-style-type: none"><li>• Allows you to play back a recording on the tape.</li><li>• Allows you to access data stored on the memory card or to transfer still/moving images stored on the memory card to a computer.</li></ul>

VIDEO/MEMORY Switch Position
<b>VIDEO</b> :
<ul style="list-style-type: none"><li>• Allows you to record on a tape or play back a tape. If "REC SELECT" is set to "→ <b>CO</b> / → <b>M</b>" in the DSC Menu Screen, still images are recorded on the memory card as well.</li><li>• Zoom magnification over 10X (GR-DX300) or 16X (GR-DX95/DX75) is available (☞ pg. 13, 32).</li></ul>
<b>MEMORY</b> :
Allows you to record on a memory card or access data stored on a memory card.

## Power-Linked Operation

When the Power Switch **12** is set to "A" or "M", you can also turn on/off the camcorder by opening/closing the LCD monitor or pulling out/pushing in the viewfinder.

## Zooming

To produce the zoom in/out effect, or an instantaneous change in image magnification.

### Zoom In

Turn the Power Zoom (SHUTTLE SEARCH) Ring **18** clockwise.

### Zoom Out

Turn the Power Zoom (SHUTTLE SEARCH) Ring **18** counterclockwise.

- The further you turn the Power Zoom Ring **18** the quicker the zoom action.

### NOTES:

- Focusing may become unstable during Zooming. In this case, set the zoom while in Record-Standby, lock the focus by using the manual focus (☞ pg. 30), then zoom in or out in Record mode.
- Zooming is possible to a maximum of 500X (GR-DX300) or 700X (GR-DX95/DX75), or it can be switched to 10X (GR-DX300) or 16X (GR-DX95/DX75) magnification using the optical zoom (☞ pg. 32).
- Zoom magnification of over 10X (GR-DX300) or 16X (GR-DX95/DX75) is done through Digital image processing, and is therefore called Digital Zoom.
- During Digital zoom, the quality of image may suffer.
- Digital zoom cannot be used when the **VIDEO/MEMORY** Switch **25** is set to "MEMORY" (☞ "VIDEO/MEMORY Switch Position").
- Macro shooting (as close as approx. 5 cm (2") to the subject) is possible when the Power Zoom Ring **18** is turned all the way clockwise. Also see "TELE MACRO" in the Menu Screen on page 33.

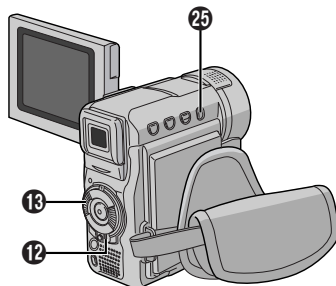

Refer to the diagrams on page 52 and 54 for the controls, indications, indicators and connectors mentioned.

During recording, a time code is recorded on the tape. This code is to confirm the location of the recorded scene on the tape during playback.

If recording starts from a blank portion, the time code begins counting from "00:00:00" (minute:second:frame). If recording starts from the end of a previously recorded scene, the time code continues from the last time code number.

To perform Random Assemble Editing (☞ pg. 41 – 43), time code is necessary. If during recording a blank portion is left partway through the tape, the time code is interrupted. When recording is resumed, the time code starts counting up again from "00:00:00". This means the camcorder may record the same time codes as those existing in a previously recorded scene. To prevent this, perform "RECORDING FROM THE MIDDLE OF A TAPE" in the following cases;

- When shooting again after playing back a recorded tape.
- When power shuts off during shooting.
- When a tape is removed and re-inserted during shooting.
- When shooting using a partially recorded tape.
- When shooting on a blank portion located partway through the tape.
- When shooting again after shooting a scene then opening/closing the cassette holder cover.

## Display

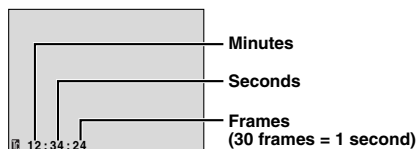

Frames are not displayed during recording.

## RECORDING FROM THE MIDDLE OF A TAPE

**1** Play back a tape or use Blank Search (☞ pg. 15) to find the spot at which you want to start recording, then engage the Still Playback mode (☞ pg. 14, "Normal Playback").

**2** Set the Power Switch **Ⓟ** to "A" or "M" while pressing down the Lock Button **Ⓛ** located on the switch, then start recording.

## NOTES:

- The time code cannot be reset.
- During fast-forwarding and rewinding, the time code indication does not move smoothly.
- The time code is displayed only when "TIME CODE" is set to "ON" (☞ pg. 35).

**1** Load a tape (☞ pg. 9).

**2** Set the VIDEO/MEMORY Switch **Ⓟ** to "VIDEO", then set the Power Switch **Ⓟ** to "PLAY" while pressing down the Lock Button **Ⓛ** located on the switch. To start playback, press **▶/||** **Ⓛ**.

- To stop playback temporarily (Still Playback), press **▶/||** **Ⓛ**.
- To stop playback, press **■** **Ⓛ**.
- Turn the SHUTTLE SEARCH Ring **Ⓛ** counterclockwise (**◀**) and release to rewind, or clockwise (**▶**) and release to fast-forward the tape during Stop mode.
- High-speed picture search (Shuttle Search) is possible by turning the SHUTTLE SEARCH Ring **Ⓛ** counterclockwise (**◀**) or clockwise (**▶**) during playback (holding the SHUTTLE SEARCH Ring **Ⓛ** continues search until released).
- Press the Zoom Button **T** **Ⓛ** on the remote control to zoom in (up to 44X\*/50X\*\*), or **W** **Ⓛ** to zoom out. You can also magnify a particular part of an image (☞ pg. 39).
  - \* GR-DX95/DX75 only
  - \*\* GR-DX300 only
- At any time, pressing **▶/||** **Ⓛ** resumes normal playback.

## Slow-Motion Playback/Playback Special Effects/ Playback Zoom:

Available only with the remote control (☞ pg. 39)

## To Control The Speaker Volume:

..... press **VOL. +** **Ⓛ** to turn up the volume, or **-** **Ⓛ** to turn down the volume.

## ATTENTION

During Shuttle Search, parts of the picture may not be clearly visible, particularly on the left side of the screen.



Refer to the diagrams on page 52 and 54 for the controls, indications, indicators and connectors mentioned.

## Blank Search

Helps you find where you should start recording in the middle of a tape to avoid time code interruption (☞ pg. 14).

**1** Load a tape (☞ pg. 9).

**2** Set the **VIDEO/MEMORY Switch 25** to "VIDEO", then set the Power Switch **12** to "PLAY" while pressing down the Lock Button **11** located on the switch.

**3** Press **BLANK SEARCH 24**.

- "BLANK SEARCH" ■ appears and the camcorder automatically starts reverse or forward shuttle search, then stops at the spot which is about 3 seconds of tape before the beginning of the detected blank portion.

**To cancel Blank Search midway . . .**

..... press ■ **7**.

### NOTES:

- In step 3, if the current position is at a blank portion the camcorder searches in the reverse direction, and if the current position is at a recorded portion the camcorder searches in the forward direction.
- Blank Search does not work if "HEAD CLEANING REQUIRED. USE CLEANING CASSETTE" has appeared with the tape.
- If the beginning or end of the tape is reached during Blank Search, the camcorder stops automatically.
- A blank portion which is shorter than 5 seconds of tape may not be detected.
- The detected blank portion may be located between recorded scenes. Before you start recording, make sure there is no recorded scene after the blank portion.

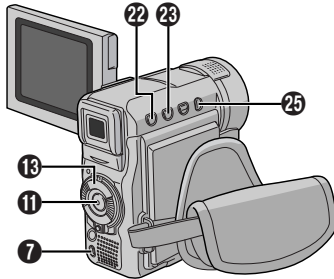
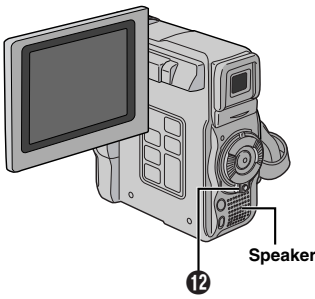

### NOTES:

- If Stop mode continues for 5 minutes when power is supplied from a battery, the camcorder shuts off automatically. To turn on again, set the Power Switch **12** to "OFF", then to "PLAY".
- The playback picture can be viewed in the LCD monitor, viewfinder or on a connected TV (☞ pg. 16).
- You can also view the playback picture on the LCD monitor with it flipped over and pushed against the camera body.
- LCD monitor/viewfinder indications:  
When power is supplied from a battery: the "☐" battery pack remaining power indicator is displayed.  
When power is supplied from an AC outlet: "☐" does not appear.
- When a cable is connected to the AV connector, the sound is not heard from the speaker.
- If still playback continues for more than about 3 minutes, the camcorder's Stop mode is automatically engaged.
- When ►/II **11** is pressed to engage still playback, the image may not pause immediately while the camcorder stabilizes the still image.

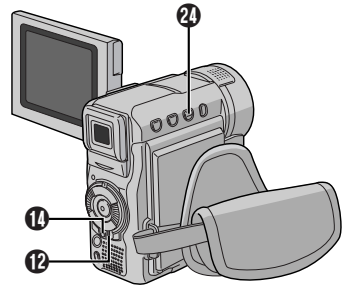

Refer to the diagrams on page 52 and 54 for the controls, indications, indicators and connectors mentioned.

## Connections

- 1** Make sure all units are turned off.
  - 2** Connect the camcorder to a TV or VCR as shown in the illustration.  
**If using a VCR . . . go to step 3.**  
**If not . . . go to step 4.**
  - 3** Connect the VCR output to the TV input, referring to your VCR's instruction manual.
  - 4** Turn on the camcorder, the VCR and the TV.
  - 5** Set the VCR to its AUX input mode, and set the TV to its VIDEO mode.
- To choose whether or not the following displays appear on the connected TV . . .**
- Date/Time  
 .... set "DATE/TIME" to "AUTO", "ON" or "OFF" in the Menu Screen (☞ pg. 34, 36).  
 Or, press **DISPLAY** (Ⓜ) on the remote control to turn on/off the date indication.
  - Time Code  
 .... set "TIME CODE" to "ON" or "OFF" in the Menu Screen (☞ pg. 35, 36).
  - Indications other than date/time and time code  
 .... set "ON SCREEN" to "LCD", "LCD/TV" or "OFF" in the Menu Screen (☞ pg. 34, 36).

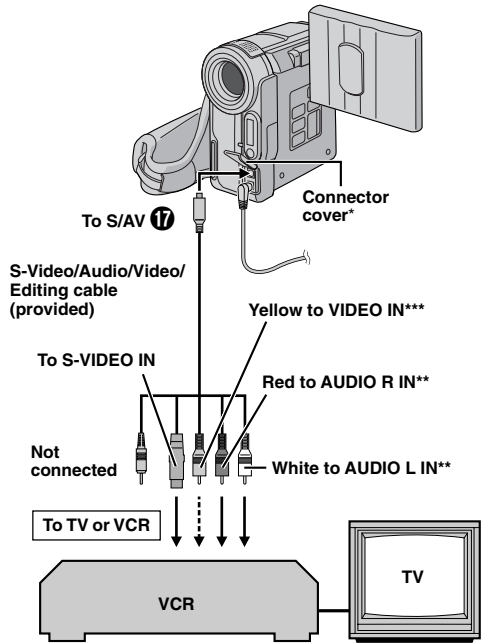

### NOTES:

- It is recommended to use the AC Adapter as the power supply instead of the battery pack (☞ pg. 7).
- To monitor the picture and sound from the camcorder without inserting a tape or memory card, set the camcorder's Power Switch (Ⓜ) to "A" or "M", then set your TV to the appropriate input mode.
- Make sure you adjust the TV sound volume to its minimum level to avoid a sudden burst of sound when the camcorder is turned on.
- If you have a TV or speakers that are not specially shielded, do not place the speakers adjacent to the TV as interference will occur in the camcorder playback picture.
- If no image is displayed or no sound is heard from the TV, set "S/AV INPUT" to "OFF" in the Menu Screen (☞ pg. 35).
- While the S-Video/Audio/Video/Editing cable is connected to the S/AV connector (1), sound cannot be heard from the speaker.

\* When connecting the cables, open this cover.

\*\* The audio connection is not required for watching still images only.

\*\*\* Connect when the S-Video connection is not used.

Refer to the diagrams on page 52 and 54 for the controls, indications, indicators and connectors mentioned.



## Basic Shooting (Snapshot)

You can use your camcorder as a digital still camera for taking snapshots.

Perform the procedures listed below before continuing.

- Power (☞ pg. 7)
- Grip Adjustment (☞ pg. 8)
- Viewfinder Adjustment (☞ pg. 8)
- Loading A Memory Card (☞ pg. 11)
- Picture Quality/Image Size Setting (☞ pg. 11)

**1** Set the **VIDEO/MEMORY Switch** 25 to "MEMORY", then set the Power Switch 12 to "A" or "M" while pressing down the Lock Button 11 located on the switch. Open the LCD monitor fully or pull out the viewfinder fully.

**2** Press **SNAPSHOT** 9. "PHOTO" ■ appears while the snapshot is being taken. The image is recorded on the memory card.

- Still images are recorded in the snapshot mode with no frame.

### To Delete Unwanted Still Images . . .

..... when unwanted still images are stored in the memory card or its memory is full, refer to "Deleting Files" (☞ pg. 20) and delete unwanted still images.

### To Remove The Shutter Sound . . .

..... when you do not want to hear the shutter sound, set "BEEP" to "OFF" in the Menu Screen (☞ pg. 34). The sound is no longer heard from the speaker.

## NOTES:

- Even if "DIS" is set to "ON" (☞ pg. 33), the Stabilizer will be disabled.
- If Snapshot recording is not possible, "PHOTO" ■ blinks when **SNAPSHOT** 9 is pressed.
- If Program AE with special effects (☞ pg. 27) is engaged, certain modes of Program AE with special effects are disabled during Snapshot recording. In such a case, the icon blinks.
- If shooting is not performed for approx. 5 minutes when the Power Switch 12 is set to "A" or "M" and power is supplied from the battery pack, the camcorder shuts off automatically to save power. To perform shooting again, close the LCD monitor and re-open it. When using the viewfinder, push back it in and pull it out again.
- The Motor Drive mode (☞ pg. 29) is disabled when the **VIDEO/MEMORY Switch** 25 is set to "MEMORY".
- When a cable is connected to the S/AV connector 17, the shutter sound is not heard from the speaker, however it is recorded onto the tape.
- Still images taken are compliant to DCF (Design rule for Camera File system). They do not have any compatibility with devices which are not compliant to DCF.

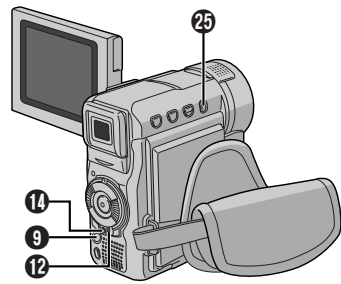
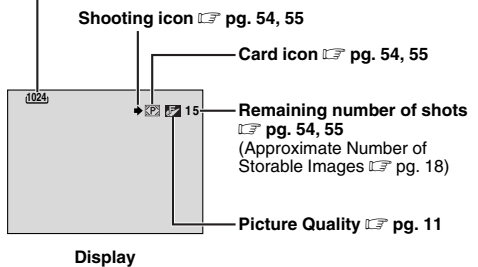
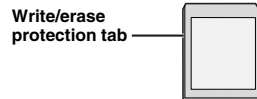

Image Size ☞ pg. 11



### To Protect Valuable Files (available only for SD Memory Card) . . .



..... slide the write/erase protection tab on the side of the memory card in the direction of "LOCK". This prevents the memory card from being recorded over. To record on this memory card, slide the tab back to the position opposite to "LOCK" before loading it.

Refer to the diagrams on page 52 and 54 for the controls, indications, indicators and connectors mentioned.

## Approximate Number of Storable Images

□ : SD Memory Card

■ : MultiMediaCard

<GR-DX95/DX75>

Image Size/ Picture Quality	Memory Card			
	8MB**	16MB***	32MB***	64MB***
1024 x 768/ FINE	20	45	95	190
	24	48	100	
1024 x 768/ STANDARD	65	145	310	605
	75	160	320	
640 x 480/ FINE	45	95	205	405
	55	105	215	
640 x 480/ STANDARD	160	295	625	1215
	190	320	645	

<GR-DX300>

Image Size/ Picture Quality	Memory Card			
	8MB**	16MB***	32MB***	64MB***
1600 x 1200/ FINE	8	19	41	80
	10	21	42	
1600 x 1200/ STANDARD	28	60	130	275
	34	65	135	
1280 x 960/ FINE	13	29	60	125
	16	32	60	
1280 x 960/ STANDARD	45	95	205	425
	50	105	215	
1024 x 768/ FINE	21	47	95	200
	25	50	100	
1024 x 768/ STANDARD	65	145	310	640
	75	160	320	
640 x 480/ FINE	47	95	205	425
	55	105	215	
640 x 480/ STANDARD	160	295	625	1285
	190	320	645	

\*\* MultiMediaCard (8 MB) → provided with GR-DX300/DX95.

\*\*\* Optional

### NOTE:

The number of storable images depends on the selected picture quality as well as the composition of the subjects in the images and the type of memory card being used.

## Normal Playback

**1** Load a memory card (☞ pg. 11).

**2** Set the **VIDEO/MEMORY** Switch **25** to “MEMORY”, then set the Power Switch **12** to “PLAY” while pressing down the Lock Button **11**.

• A stored file is displayed.

**3** Select the type of file as necessary (IMAGE or E-MAIL CLIP): Press **SELECT/SET** **3**. Press + or - **5** to select the type of file, then press **SELECT/SET** **3** again.

**4 IMAGE:** Turn the **SHUTTLE SEARCH** Ring **13** clockwise (▶▶) to display the next image, or counterclockwise (◀◀) to display the previous image. **E-MAIL CLIP:** Press ▶/II **11** to view video clips. To stop video clip playback, press ■ **7**.

### To Magnify The Stored Images

Press the Zoom Button **T** **35** on the remote control to zoom in (up to 44X\*/50X\*\*), or **W** **35** to zoom out. You can also magnify a particular part of an image (☞ pg. 39).

• By pressing ▶/II **11**, **INDEX** **1**, **INFO** **6** or turning the **SHUTTLE SEARCH** Ring ◀◀/▶▶ **13** magnification is cancelled.

\* GR-DX95/DX75 only.

\*\* GR-DX300 only.

### To Adjust The Brightness Of The Display

See “To Adjust The Brightness Of The Display” on page 12.

### NOTES:

- Pressing **INFO** **6** gives you details on the displayed file (☞ pg. 19, “Viewing File Information”).
- You can also overview several files at a time (☞ pg. 19, “Index Playback”).
- You can turn off the on-screen playback display (☞ pg. 19, “Removing On-Screen Display”).
- Images shot in a file size that is not compatible with this camcorder will be displayed as reduced-size thumbnail images. These thumbnail images cannot be transferred to a PC.
- Images shot with devices (such as JVC GR-DVM70) that are not compatible with DCF cannot be viewed with this camcorder; “UNSUPPORTED FILE!” will be displayed.

[For Normal Playback: IMAGE]

To display the next image

To display the previous image

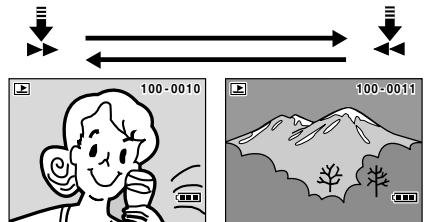

[For Auto Playback: IMAGE]

Refer to the diagrams on page 52 and 54 for the controls, indications, indicators and connectors mentioned.

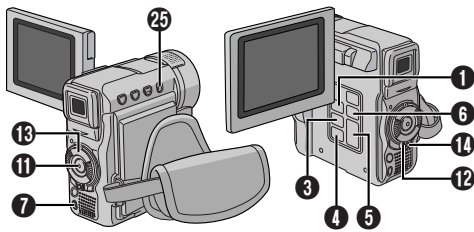

## Viewing File Information

You can get the relevant file information by pressing the **INFO** button **6** during normal playback or Index playback.

```
FOLDER : 100JVCGR
FILE   : DVC00010
DATE   : OCT 03 03
SIZE   : 1024X768
QUALITY : FINE
PROTECT : OFF
```

Info Screen: IMAGE

## Auto Playback

You can run through all the images stored on memory automatically.

**1** Perform steps **1** through **3** of "Normal Playback". Make sure an IMAGE file is displayed (☞ pg. 18).

**2** Press **▶/II** **11**.

- If you turn the **SHUTTLE SEARCH** Ring **13** counterclockwise (**◀**) during Auto Playback, images are displayed in descending order.
- If you turn the **SHUTTLE SEARCH** Ring **13** clockwise (**▶**) during Auto Playback, images are displayed in ascending order.

**3** To end Auto Playback, press **■** **7**.

### NOTE:

Even if you shoot a new image after playing back a low-numbered one, this will not overwrite an existing image, because new images are automatically stored after the last-recorded one.

## Index Playback

You can view several different files stored on the memory card at a time. This browsing capability makes it easy to locate a particular file you want.

**1** Perform steps **1** through **3** of "Normal Playback" (☞ pg. 18).

**2** Press **INDEX** **1**. The Index Screen appears.

**3** Press **+** or **-** **5** to move the frame to the desired file.

- Turning the **SHUTTLE SEARCH** Ring **13** clockwise (**▶**) displays the next page and counterclockwise (**◀**) displays the previous page.
- Pressing **INFO** **6** gives you details on the currently selected file (☞ "Viewing File Information").

**4** Press **SELECT/SET** **3**. The selected file is displayed.

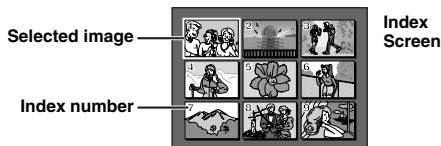

FOLDER : Folder name (☞ pg. 24)

FILE : File name (☞ pg. 24)

DATE : Date the file was made

SIZE : Image size (☞ pg. 11)

QUALITY : Picture quality (IMAGE files only ☞ pg. 11)

TIME : Playback time

(E-MAIL CLIP files only ☞ pg. 22)

PROTECT : When set to ON, the file is protected from accidental erasure (☞ pg. 20).

- Press **INFO** **6** again to close the Info Screen.

### NOTE:

With images shot with another device or processed on a PC, "QUALITY: ---" will be displayed.

## Removing On-Screen Display

**1** Perform steps **1** through **3** of "Normal Playback". Make sure an IMAGE file is displayed (☞ pg. 18).

**2** Press **MENU** **4**. The Menu Screen appears. Press **+** or **-** **5** to select "DISPLAY", then press **SELECT/SET** **3**.

**3** Press **+** or **-** **5** to select "OFF", then press **SELECT/SET** **3**. The operation mode indicator, folder/file number indicator and battery indicator (☞ ) disappear.

- To display the indicators again, select "ON" in step **3**.

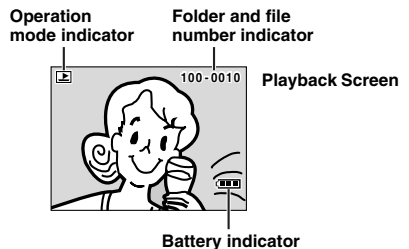

Refer to the diagrams on page 52 and 54 for the controls, indications, indicators and connectors mentioned.

## Protecting Files

The Protect mode helps prevent the accidental erasure of files.

**1** Perform steps **1** through **3** of “Normal Playback” (☞ pg. 18).

**2** Press **MENU** **1**. The Menu Screen appears. Press + or - **6** to select “PROTECT”, then press **SELECT/SET** **3**.

**3** Press + or - **6** to select the desired mode.

**CURRENT** : Protects the currently displayed file.  
**PROT.ALL** : Protects all files stored on the memory card.

**4** Press **SELECT/SET** **3**. The PROTECT Screen appears.

- If you selected “CURRENT” in step **3**, turn the **SHUTTLE SEARCH** Ring **18** counterclockwise (◀◀) or clockwise (▶▶) to select the desired file.

**5** Press + or - **6** to select “EXECUTE” and press **SELECT/SET** **3**.

- To cancel protection, select “RETURN”.

### NOTES:

- If the “**On**” mark appears, the currently displayed file is protected.
- When the memory is initialized or corrupted, even protected files are deleted. If you do not want to lose important files, transfer them to a PC and save them.

## TO REMOVE PROTECTION

Before doing the following, perform steps **1** and **2** above.

**3** Press + or - **6** to select the desired mode.

**CURRENT** : Removes protection from the currently displayed file.

**CANC.ALL** : Removes protection from all files stored on the memory card.

**4** Press **SELECT/SET** **3**. The PROTECT Screen appears.

- If you selected “CURRENT”, turn the **SHUTTLE SEARCH** Ring **18** counterclockwise (◀◀) or clockwise (▶▶) to select the desired file.

**5** Press + or - **6** to select “EXECUTE” and press **SELECT/SET** **3**.

- To cancel selection, select “RETURN”.

## Deleting Files

Previously stored files can be deleted either one at a time or all at once.

**1** Perform steps **1** through **3** of “Normal Playback” (☞ pg. 18).

**2** Press **MENU** **1**. The Menu Screen appears. Press + or - **6** to select “DELETE”, then press **SELECT/SET** **3**.

**3** Press + or - **6** to select the desired mode.

**CURRENT** : Deletes the currently displayed file.  
**ALL** : Deletes all files stored on the memory card.

**4** Press **SELECT/SET** **3**. The DELETE Screen appears.

- If you selected “CURRENT” in step **3**, turn the **SHUTTLE SEARCH** Ring **18** counterclockwise (◀◀) or clockwise (▶▶) to select the desired file.

**5** Press + or - **6** to select “EXECUTE” and press **SELECT/SET** **3**.

- If the “**On**” mark appears, the selected file is protected and cannot be deleted (☞ “Protecting Files”).
- To cancel deletion, select “RETURN”.

### NOTES:

- Protected files (☞ “Protecting Files”) cannot be deleted with the above operation. To delete them, remove protection first.
- Once files are deleted, they cannot be restored. Check files before deleting.

## CAUTION

Do not remove the memory card or perform any other operation (such as turning off the camcorder) during deletion. Also, be sure to use the provided AC Adapter, as the memory card may be corrupted if the battery becomes exhausted during deletion. If the memory card becomes corrupted, initialize it. (☞ pg. 24)

### Display



### Menu Screen: IMAGE

Refer to the diagrams on page 52 and 54 for the controls, indications, indicators and connectors mentioned.

## NAVIGATION Function

The NAVIGATION Function helps you check tape contents by making thumbnail images on a memory card.

### TO MAKE THUMBNAIL IMAGES DURING TAPE RECORDING

- 1 Load a memory card (pg. 11) and cassette (pg. 9). Set the VIDEO/MEMORY Switch ② to "VIDEO", then set the Power Switch ⑫ to "M" while pressing down the Lock Button ⑩.
- 2 Press MENU ①. The Menu Screen appears. Press + or - ⑤ to select "A (CAMERA)" and press SELECT/SET ③.
- 3 Press + or - ⑤ to select "NAVIGATION" and press SELECT/SET ③. The Sub Menu appears. Select the desired mode by pressing + or - ⑤.

MANUAL: The camcorder makes a thumbnail image only when NAVI STORE ② is pressed after a recording is finished (factory preset).

Modes other than "MANUAL": "MANUAL" is displayed and the camcorder always makes a thumbnail image when the recording time is over the selected period of time.

Press SELECT/SET ③.

- 4 Press + or - ⑤ to select "RETURN" and press SELECT/SET ③ twice. The Menu Screen closes.
- 5 Press the Recording Start/Stop Button ⑪ to start tape recording.
- 6 Press the Recording Start/Stop Button ⑪ to stop tape recording.  
If "MANUAL" is selected in step 3, press NAVI STORE ②.  
• "NAVI STORE" appears and the image of the point where recording is started is stored on the memory card as a thumbnail image.

#### NOTE:

The remaining number of storable thumbnail images also appears on the screen when it reaches 10 or less. If "REC SELECT" is set to "→ [RECORD] → [M]" in the Menu Screen, the number shows how many 640 x 480 pixel images can be stored.

### TO FIND SCENES ON TAPE USING THUMBNAIL IMAGES (NAVIGATION SEARCH)

- 1 Load a memory card (pg. 11) and cassette (pg. 9). Set the VIDEO/MEMORY Switch ② to "VIDEO", then set the Power Switch ⑫ to "PLAY" while pressing down the Lock Button ⑩.
- 2 Press NAVI ①. The loaded tape's NAVIGATION thumbnail image screen appears.  
• Turn the SHUTTLE SEARCH Ring ⑬ clockwise (▶▶) to display the next page, or counterclockwise (◀◀) to display the previous page.

- 3 Press + or - ⑤ to select desired image and press SELECT/SET ③.

• "NAVIGATION SEARCH" appears blinking and the camcorder starts searching the tape for the relevant point of the selected thumbnail image.

To cancel NAVIGATION Search midway . . .

- ..... press ▶/|| ⑪ or ■ ⑦, or turn the SHUTTLE SEARCH Ring ⑬.

### TO ADD THUMBNAIL IMAGES DURING TAPE PLAYBACK

- 1 Perform step 1 of "TO FIND SCENES ON TAPE USING THUMBNAIL IMAGES (NAVIGATION SEARCH)".
- 2 Press ▶/|| ⑪ to start tape playback.
- 3 Press NAVI STORE ② at the desired point.  
• "NAVI STORE" appears and the image of the point where NAVI STORE ② is pressed is stored on the memory card as a thumbnail image.

### TO DELETE THUMBNAIL IMAGES

- 1 Load a memory card (pg. 11). Set the VIDEO/MEMORY Switch ② to "VIDEO", then set the Power Switch ⑫ to "PLAY" while pressing down the Lock Button ⑩.
- 2 Press MENU ①. The Menu Screen appears. Press + or - ⑤ to select "V (VIDEO)" and press SELECT/SET ③. Press + or - ⑤ to select "NAVI.DEL." and press SELECT/SET ③. The Sub Menu appears.
- 3 By pressing + or - ⑤ . . .  
..... select "IMAGE SEL." to delete the currently displayed thumbnail image.  
..... select "TAPE SEL." to delete all thumbnail images for the tape which contains the currently displayed image.  
..... select "ALL." to delete all thumbnail images stored on the memory card at once.  
Then, press SELECT/SET ③. The NAVIGATION screen appears.
- 4 Press + or - ⑤ to select "EXECUTE", then press SELECT/SET ③.

- To cancel deletion, select "RETURN". Turn the SHUTTLE SEARCH Ring ⑬ clockwise (▶▶) to display the next image, or counterclockwise (◀◀) to display the previous image.
- Thumbnail images cannot be deleted during tape playback.

#### NOTE:

Once images are deleted, they cannot be restored. Check images before deleting.

Continued on next page.

Refer to the diagrams on page 52 and 54 for the controls, indications, indicators and connectors mentioned.

## CAUTION

Do not remove the memory card or perform any other operation (such as turning off the camcorder) during deletion. Also, be sure to use the provided AC Adapter, as the memory card may be corrupted if the battery becomes exhausted during deletion. If the memory card becomes corrupted, initialize it. (☞ pg. 24)

## IMPORTANT

- Be sure to always use the same tape and memory card together as they were during recording; otherwise, the camcorder cannot recognize Tape and Memory Card IDs to perform NAVIGATION function properly.
- Check if an appropriate tape and memory card are loaded when the following messages appear: "NO ID ON TAPE OR CARD", "UNABLE TO USE NAVIGATION", "THIS MEMORY CARD IS NOT COMPATIBLE".
- If you change the memory card while shooting on one tape, two memory cards will share the tape's thumbnail images. We recommend that you use one memory card for one tape.
- NAVIGATION Search does not work if the current position is at a blank portion on the tape. Also, do not leave a blank portion partway through the tape when shooting; otherwise, NAVIGATION function does not work properly.
- Before shooting newly over a recorded tape, be sure to delete all thumbnail images of the previous recording from the relevant memory card.
- If you copy thumbnail images from one memory card to another via a PC, NAVIGATION Search does not work with the copied memory card.

## E-Mail Clip Recording

You can make video clips from real-time camera image or recorded video footage and store them in a memory card as files which can be conveniently sent via e-mail.

### TO MAKE VIDEO CLIPS FROM REAL-TIME CAMERA IMAGE

**1** Load a memory card (☞ pg. 11). Set the **VIDEO/MEMORY** Switch **25** to "MEMORY", then set the Power Switch **12** to "A" or "M" while pressing down the Lock button **14** located on the switch.

**2** Press **E-MAIL 6**. "E-CLIP" appears and the camcorder enters the E-Mail Clip Record-Standby mode.

**3** Press the Recording Start/Stop Button **11** to start E-Mail Clip Recording.

**4** Press the Recording Start/Stop Button **11** to stop E-Mail Clip Recording. "COMPLETED" is displayed, then the camcorder re-enters the E-Mail Clip Record-Standby mode.

**5** Press **E-MAIL 6** to end E-Mail Clip Recording. The normal screen reappears.

**To view video clips stored on a memory card . . .**  
..... ☞ pg. 18.

### TO MAKE VIDEO CLIPS FROM RECORDED VIDEO FOOTAGE

**1** Load a memory card (☞ pg. 11) and cassette (☞ pg. 9). Set the **VIDEO/MEMORY** Switch **25** to "VIDEO", then set the Power Switch **12** to "PLAY" while pressing down the Lock Button **14** located on the switch.

**2** Press **▶/II 11** to start tape playback.

**3** Press **E-MAIL 6**. "E-CLIP" appears and the camcorder enters the E-Mail Clip Record-Standby mode.

**4** Press **SNAPSHOT 9** to start E-Mail Clip Recording.

**5** Press **SNAPSHOT 9** to stop E-Mail Clip Recording. "COMPLETED" is displayed, then the camcorder re-enters the E-Mail Clip Record-Standby mode.

**6** Press **E-MAIL 6** to end E-Mail Clip Recording. The normal screen reappears.

#### To cancel E-Mail Clip Recording . . .

..... after step **3**, press **E-MAIL 6** again or press **■ 7** to stop tape playback.

#### To view video clips stored on a memory card . . .

..... ☞ pg. 18.

#### NOTES:

- Video clips are stored in 160 x 120-pixel format.
- Playback operation cannot be performed during E-Mail Clip Recording.
- If the end of the tape is reached in step **3**, the E-Mail Clip Record-Standby mode will be automatically cancelled.
- The video clip files made with this camcorder are MPEG4 compliant, however, some MPEG4 files made with other devices may not be played back with this camcorder.
- 240 x 176 size video clip files made with other devices or video clip files that are longer than 3 minutes cannot be played back with this camcorder. "UNSUPPORTED FILE!" is displayed.
- You can delete unwanted video clips (☞ pg. 20, "Deleting Files") or protect important ones from accidental erasure (☞ pg. 20, "Protecting Files").
- Video noise may appear while viewing video clips in the LCD monitor or viewfinder, however, this noise is not present in the actual video clips stored on the memory card.
- You can also view video clips on your PC by using Windows® Media Player. Refer to the instructions of the PC and software.

#### Approximate recording time

MultiMediaCard (8MB)	8 min.
----------------------	--------

- Approximate maximum recording time per video clip is 3 minutes.

**Refer to the diagrams on page 52 and 54 for the controls, indications, indicators and connectors mentioned.**

## Dubbing Still Images Recorded On A Tape To A Memory Card

Still images can be dubbed from a tape to a memory card.

- 1 Load a memory card (📄 pg. 11) and cassette (📄 pg. 9).
- 2 Set the **VIDEO/MEMORY Switch** (25) to "VIDEO", then set the Power Switch (12) to "PLAY" while pressing down the Lock Button (1).
- 3 Press **MENU** (4). The Menu Screen appears. Press + or - (5) to select "VIDEO" and press **SELECT/SET** (3).
- 4 Press + or - (5) to select "COPY" and press **SELECT/SET** (3). The Sub Menu appears. Press + or - (5) to select "ON" and press **SELECT/SET** (3). Selection is complete.
- 5 Press + or - (5) to select "RETURN" and press **SELECT/SET** (3) twice. The normal playback screen reappears.
- 6 To select a video image to be dubbed, start playback by pressing ▶/II (11). At the moment you find the image you wish to dub, press it again to engage Still Playback.
- 7 To start dubbing, press **SNAPSHOT** (9). The selected image is stored on the memory card.
  - "➡" blinks during dubbing.

### NOTES:

- If **SNAPSHOT** (9) is pressed in step 7 when a memory card is not loaded, the message "COPYING FAILED" is displayed. (📄 pg. 56)
- To change the Snapshot mode for dubbing, (📄 pg. 29).
- If an image recorded on the tape using the WIDE mode (📄 pg. 33) is dubbed to a memory card, the WIDE mode identifying signal is not dubbed with it.
- To use Playback Special Effects with a video image you wish to dub, perform up to step 7 using the remote control (📄 pg. 39).
- Images are dubbed in 640 x 480 pixels.

Display



Menu Screen

## Setting Print Information (DPOF Setting)

This camcorder is compatible with the DPOF (Digital Print Order Format) standard in order to support future systems such as automatic printing, which records information about the still images you wish to print (such as the number of prints to make). There are 2 print information settings available: "TO PRINT ALL STILL IMAGES (ONE PRINT FOR EACH)" explained below and "TO PRINT BY SELECTING STILL IMAGES AND NO. OF PRINTS".

### TO PRINT ALL STILL IMAGES (ONE PRINT FOR EACH)

- 1 Set the **VIDEO/MEMORY switch** (25) to "MEMORY", then set the Power Switch (12) to "PLAY", while pressing down the Lock Button (1) located on the switch.
  - Make sure an IMAGE file is displayed (📄 pg. 18, "Normal Playback").
- 2 Press **MENU** (4). The Menu Screen appears.
- 3 Press + or - (5) to select "DPOF" and press **SELECT/SET** (3). The Sub Menu appears.
- 4 Press + or - (5) to select "ALL 1" and press **SELECT/SET** (3). Selection is complete. The DPOF Screen appears.
- 5 Press + or - (5) to select "EXECUTE" and press **SELECT/SET** (3). The normal playback screen appears.
  - To cancel selection, press + or - (5) to select "RETURN" and press **SELECT/SET** (3).

### To Reset The Setting . . .

..... select "RESET" in step 4. The setting is reset to 0 for all still images.

### TO PRINT BY SELECTING STILL IMAGES AND NO. OF PRINTS

- 1 Perform steps 1 through 3 of "TO PRINT ALL STILL IMAGES (ONE PRINT FOR EACH)".
- 2 Press + or - (5) to select "CURRENT" and press **SELECT/SET** (3). Selection is complete. The DPOF Screen appears.
- 3 Turn the **SHUTTLE SEARCH Ring** (13) counterclockwise (◀) or clockwise (▶) so that the image you wish to print appears.
- 4 Press + or - (5) to move the highlight bar to the SHEETS number indication and press **SELECT/SET** (3).

Continued on next page.

**5** Select the number of prints by pressing + or – **6** and press **SELECT/SET 3**.

Repeat steps **3** through **5** for the desired number of prints.

- The number of prints can be set up to 15.
- To correct the number of prints, select the image again and change the number.

**6** Press + or – **6** to select “RETURN” and press **SELECT/SET 3**. Selection is complete. “SAVE?” appears.

- If you did not change any settings in step **3** through **5**, the Menu Screen reappears.

**7** Press + or – **6** to select “EXECUTE”, then press **SELECT/SET 3** to save the setting you have just made.

- To cancel selection, press + or – **6** to select “CANCEL” and press **SELECT/SET 3**.

#### To Reset The No. Of Prints . . .

..... select “RESET” in step **4** of “TO PRINT ALL STILL IMAGES (ONE PRINT FOR EACH)” on pg. 23. The number of prints is reset to 0 for all still images.

### CAUTION

While performing the above, never disconnect power, as this may cause the memory to be corrupted. For safety, all buttons including the Power Switch **12** are disabled in step **6**.

#### NOTES:

- “BATTERY LOW” appears if the battery remaining power is too low.
- If you load a memory card already set as shown above in a printer compatible with DPOF, it will make prints of the selected still images automatically.
- To print images recorded on a tape, first dub them to a memory card (☞ pg. 23).

### Making A New Folder

New files you are going to store can be separated from previously stored files by resetting the file name to DVC00001; these new files will be stored in a new folder.

**1** Perform steps **1** through **3** of “Normal Playback” (☞ pg. 18).

**2** Press **MENU 4**. The Menu Screen appears. Press + or – **6** to select “NO. RESET”, then press **SELECT/SET 3**. The NO. RESET Screen appears.

**3** Press + or – **6** to select “EXECUTE”, then press **SELECT/SET 3**. The new folder (such as “101JVCGR”) will be made and the file name of the next shot starts from DVC00001.

#### Folder and File names

Each time shooting takes place, a file name is made using a number which is larger by one than the largest number of the file names which are in use. Even if you delete an image or video clip file with a number in the middle of range, the number will not be used for a new shot; a gap will remain in the numerical sequence. If the file name reaches DVC09999, a new folder (such as “101JVCGR”) will be made and the file name will start again from DVC00001.

### Initializing A Memory Card

You can initialize a memory card anytime.

**After Initializing, all files and data stored on the memory card, including those which have been protected, are cleared.**

**1** Perform steps **1** through **3** of “Normal Playback” (☞ pg. 18).

**2** Press **MENU 4**. The Menu Screen appears. Press + or – **6** to select “FORMAT” and press **SELECT/SET 3**. The FORMAT Screen appears.

**3** Press + or – **6** to select “EXECUTE” and press **SELECT/SET 3**. The memory card is initialized. When initialization is finished, “NO IMAGES STORED” or “NO E-MAIL CLIP STORED” appears.

- To cancel initialization, press + or – **6** to select “RETURN” and press **SELECT/SET 3**.

### CAUTION

Do not perform any other operation (such as turning off the camcorder) during initialization. Also, be sure to use the provided AC Adapter, as the memory card may be corrupted if the battery becomes exhausted during initialization. If the memory card becomes corrupted initialize it.

Refer to the diagrams on page 52 and 54 for the controls, indications, indicators and connectors mentioned.



## Snapshot Flash

The flash can be used when a snapshot is taken in Record-Standby (ⓘ pg. 17, 29).

- In Full Auto mode, the flash automatically fires if it is dark (⚡ ■ appears).
- In Manual mode, you can select the “FLASH” setting as follows:

- 1** Set the Power Switch (12) to “M” while pressing down the Lock Button (11) located on the switch. Open the LCD monitor fully or pull out the viewfinder fully.
- 2** Press **MENU** (4). The Menu Screen appears.
- 3** Press + or – (5) to select “M (MANUAL)”, and press **SELECT/SET** (3).
- 4** Press + or – (5) to select “FLASH”, and press **SELECT/SET** (3). The Sub Menu appears.
- 5** Press + or – (5) to select the desired mode.

**AUTO** : Fires automatically if it is dark (⚡ ■ appears).

**AUTO** (⦿) : Fires automatically if it is dark (⚡ ■ appears) and reduces the Red-Eye effect in the subject’s eyes.

**ON** : Always fires.

**OFF** : Will not fire.

Press **SELECT/SET** (3).

- 6** Press + or – (5) to select “RETURN”. Press **SELECT/SET** (3) twice to close the Menu Screen.

If “**AUTO** (⦿)” Is Selected . . .

..... the (⦿) Red-Eye reduction indicator ■ lights. Press **SNAPSHOT** (9). The flash fires twice. The first flash is for reduction of the human eye’s red reflection and the second flash is for the actual recording.

### NOTES:

- Do not fire the flash at a person at short range.
- The flash does not fire when the flash is set to “OFF” in the Menu Screen, and also when the battery remaining power is low.
- For GR-DX95/DX75 owners; the flash does not fire when it is set to “AUTO” in the Menu Screen with GAIN UP set to “OFF” (ⓘ pg. 33) and with Program AE with special effects set to “TWILIGHT” (ⓘ pg. 27).
- The flash does not fire even when it is set to “ON”, if Program AE with special effects is set to “SPORTS” or “SNOW”.
- When taking several snapshots in succession (Motor Drive Mode), the flash fires only during the first one.
- Although images shot with a flash tend to look whiter than they actually are, to compensate for this the camcorder automatically darkens the picture when using the flash. When shooting a subject at a distance where the flash light cannot reach (over approx. 2 m), set the flash to “OFF” to prevent the picture from becoming too dark or becoming too tinted.
- The color tone changes depending on the background lighting conditions, such as under fluorescent or halogen lamps.
- To change the brightness of the flash, ⓘ “Flash Brightness Adjustment”.
- While charging the flash, ⚡ ■ blinks and the flash will not fire. Although noise may appear, this is not a malfunction and is not recorded. It can take up to 10 seconds to charge the flash.

## Flash Brightness Adjustment

When a snapshot (ⓘ pg. 17, 29) is taken in the dark the camcorder fires the flash (ⓘ “Snapshot Flash”) and adjusts the brightness automatically. You can also adjust the flash brightness manually. When you find that the snapshots you took look too bright or too dark, adjust it manually.

- 1** Perform steps 1 through 3 of “Snapshot Flash”.
- 2** Press + or – (5) to select “FLASH ADJ.”, and press **SELECT/SET** (3). The parameter appears.
- 3** To intensify the flash, press + (5). To weaken the flash, press – (5).  
Adjustment range: –3 to +3.
- 4** Press **SELECT/SET** (3). Press + or – (5) to select “RETURN” and press **SELECT/SET** (3) twice to close the Menu Screen.

### NOTE:

When you change the subject you are shooting or the shooting location, set it back to ±0 as described in step 3 and take a snapshot to check the flash brightness. After doing this adjust to your desired brightness.

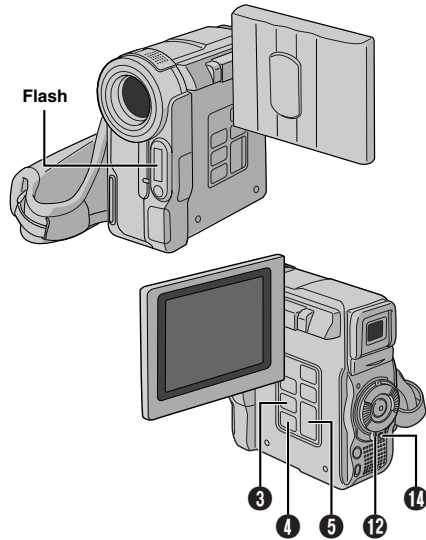

Refer to the diagrams on page 52 and 54 for the controls, indications, indicators and connectors mentioned.

## Self-Timer (GR-DX300 only)

Once the camcorder is set, the camcorder operator can become part of the scene in a more natural way, adding the final touch to a memorable picture.

**1** Set the Power Switch **12** to “**M**” while pressing down the Lock Button **11** located on the switch. Pull out the viewfinder fully or open the LCD monitor fully.

• You can tilt the LCD monitor upward to 180° so that it faces forward and view yourself while self-recording with the viewfinder pushed back.

**2** Press **MENU** **4**. The Menu Screen appears.

**3** Press + or – **5** to select “**M** (MANUAL)”, and press **SELECT/SET** **3**.

**4** Press + or – **5** to select “SELF-TIMER”, and press **SELECT/SET** **3**. The Sub Menu appears. Press + or – **5** to select “ON **☺**”, and press **SELECT/SET** **3**. Selection is complete. Press + or – **5** to select “**⏪** RETURN”, and press **SELECT/SET** **3** twice to close the Menu Screen.

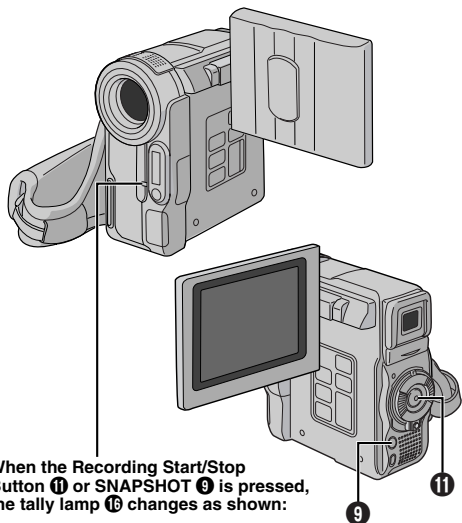

When the Recording Start/Stop Button **11** or **SNAPSHOT** **9** is pressed, the tally lamp **16** changes as shown:

Begins blinking (Self-Timer starts)

Blinks quickly (Self-Timer shooting starts soon)

Turns off (Self-Timer snapshot recording starts)

Stops blinking and stays on (Self-Timer video recording starts)

After approx. 15 sec.

**5** To engage the Self-Timer for video recording, press the Recording Start/Stop Button **11**. After 15 seconds, the beep sounds and video recording starts. To stop Self-Timer recording, press the Recording Start/Stop Button **11** again. The camcorder re-enters Record-Standby mode.

## OR

Press **SNAPSHOT** **9**. After 15 seconds, the beep sounds and snapshot recording starts. After that, the camcorder re-enters Record-Standby mode.

**6** To end Self-Timer recording, select “OFF” in step 4.

## NOTE:

If “BEEP” and “TALLY” are set to “OFF” (ⓘ pg. 34), the beep does not sound and the tally lamp **16** does not light.

## 5-Second Recording (GR-DX300 only)

Record a vacation or an important event in 5-second clips to keep the action moving. This function is available only for tape recording.

**1** Set the Power Switch **12** to “**M**” while pressing down the Lock Button **11** located on the switch. Open the LCD monitor fully or pull out the viewfinder fully.

**2** Press **MENU** **4**. The Menu Screen appears.

**3** Press + or – **5** to select “**M** (MANUAL)”, and press **SELECT/SET** **3**.

**4** Press + or – **5** to select “5S”, and press **SELECT/SET** **3**. The Sub Menu appears.

**5** Press + or – **5** to select “5S”, and press **SELECT/SET** **3**. Selection is complete. Press + or – **5** to select “**⏪** RETURN”, and press **SELECT/SET** **3** twice to close the Menu Screen.

• “5S” **■** appears.

**6** Press the Recording Start/Stop Button **11**. The tally lamp **16** lights and beep sounds to indicate the start of recording, and after 5 seconds the camcorder enters Record-Standby mode.

• Even if you press the Recording Start/Stop Button **11** again within 5 seconds after recording starts, Record-Standby mode is not engaged.

**7** To exit the 5S mode, select “OFF” in step 5.

## To Take A Snapshot In The 5-Second Recording Mode . . .

..... instead of pressing the Recording Start/Stop Button **11** in step 6, select the desired Snapshot mode in the Menu Screen, then press **SNAPSHOT** **9**. The camcorder records a 5-second still (ⓘ pg. 29). When “5S” is set to “Anim.” (ⓘ pg. 33) this function is not available.

## NOTE:

When “5S” is set to “Anim.” in the Menu Screen the 5-second recording mode is not available. Animation recording of a few frames only is taken instead (ⓘ pg. 33).

Refer to the diagrams on page 52 and 54 for the controls, indications, indicators and connectors mentioned.

## Night-Alive

Makes dark subjects or areas even brighter than they would be under good natural lighting. Although the recorded image is not grainy, it may look as if it is strobing due to the slow shutter speed.

**1** Set the Power Switch **(12)** to “**(M)**” while pressing down the Lock Button **(11)** located on the switch. Open the LCD monitor fully or pull out the viewfinder fully.

**2** Press **NIGHT** **(28)** so that the Night-Alive indicator “**(28)**” **(29)** appears.

- The shutter speed is automatically adjusted to provide up to 30 times sensitivity.
- “**A**” appears beside “**(28)**” **(29)** while the shutter speed is being automatically adjusted.

### To Deactivate Night-Alive . . .

..... press **NIGHT** **(28)** again so that the Night-Alive indicator disappears.

### NOTES:

- During Night-Alive, the following functions or settings cannot be activated and its indicator blinks or goes out:
  - Some modes of “Program AE With Special Effects” (☞ pg. 27).
  - “GAIN UP” in the CAMERA Menu (☞ pg. 33).
  - “DIS” in the MANUAL Menu (☞ pg. 33).
  - Video Flash (☞ pg. 25).
- During Night-Alive, it may be difficult to bring the camcorder into focus. To prevent this, use of manual focus and/or a tripod is recommended.

## Program AE With Special Effects

**1** Set the Power Switch **(12)** to “**(M)**” while pressing down the Lock Button **(11)** located on the switch. Open the LCD monitor fully or pull out the viewfinder fully.

**2** Press **MENU** **(1)**. The Menu Screen appears.

**3** Press + or – **(5)** to select “**(29)** (PROGRAM AE)”, then press **SELECT/SET** **(3)**.

**4** Press + or – **(5)** to select the desired mode, then press **SELECT/SET** **(3)**. Selection is complete. Press **SELECT/SET** **(3)** again. The Menu Screen closes.

- The PROGRAM AE Menu disappears and the selected mode is activated. The selected mode indicator appears.

### To Deactivate The Selected Mode . . .

..... select “OFF” in step 4.

## IMPORTANT

Some modes of Program AE with special effects cannot be used with certain Fade/Wipe Effects (☞ pg. 28). If an unusable mode is selected, its indicator blinks or goes out.

### NOTES:

- Program AE with special effects can be changed during recording or during Record-Standby.
- Some modes of Program AE special effects cannot be used during Night-Alive.

## SHUTTER

**1/60:** The shutter speed is fixed at 1/60th of a second. Black bands that usually appear when shooting a TV screen become narrower.

**1/100:** The shutter speed is fixed at 1/100th of a second. The flickering that occurs when shooting under a fluorescent light or mercury-vapor lamp is reduced.

## SPORTS

(Variable Shutter Speed: 1/250 – 1/4000)

This setting allows fast-moving images to be captured one frame at a time, for vivid, stable slow-motion playback. The faster the shutter speed, the darker the picture becomes. Use the shutter function under good lighting conditions.



## SNOW

Compensates for subjects that may otherwise appear too dark when shooting in extremely bright surroundings such as in the snow.

## SPOTLIGHT

Compensates for subjects that may otherwise appear too bright when shooting under extremely strong direct lighting such as spotlights.

### NOTE:

“SPOTLIGHT” has the same effect as –3 with the exposure control (☞ pg. 30).

## TWILIGHT

Makes evening scenes look more natural.

White Balance (☞ pg. 31) is initially set to , but can be changed to your desired setting. When Twilight is chosen, the camcorder automatically adjusts the focus from approx. 10 m (32 ft) to infinity. From less than 10 m (32 ft), adjust the focus manually.

## SEPIA

Recorded scenes have a brownish tint like old photos. Combine this with the Cinema mode for a classic look.

## B/W MONOTONE

Like black and white films, your footage is shot in B/W. Used together with the Cinema mode, it enhances the “classic film” effect.

## CLASSIC FILM\*

Gives recorded scenes a strobe effect.

## STROBE\*

Your recording looks like a series of consecutive snapshots.

## MIRROR\* (GR-DX300 only)

Creates a mirror image on the left half of the screen, juxtaposed to the normal image on the other half.

\* Available when the **VIDEO/MEMORY** Switch **(25)** is set to “VIDEO”.

**Refer to the diagrams on page 52 and 54 for the controls, indications, indicators and connectors mentioned.**

## Fade/Wipe Effects

These effects let you make pro-style scene transitions. Use them to spice up the transition from one scene to the next.

Fade or Wipe works when tape recording is started or when you stop recording.

**1** Set the **VIDEO/MEMORY Switch** **25** to "VIDEO", then set the **Power Switch** **12** to "M" while pressing down the **Lock Button** **14** located on the switch. Open the LCD monitor fully or pull out the viewfinder fully.

**2** Press **MENU** **4**. The Menu Screen appears.

**3** Press + or - **6** to select "WIPE/FADER", then press **SELECT/SET** **3**.

**4** Press + or - **6** to select the desired function, then press **SELECT/SET** **3**. Selection is complete. Press **SELECT/SET** **3** again.

- The WIPE/FADER Menu disappears and the effect is reserved. The indicator representing the selected effect appears.

**5** Press the **Recording Start/Stop Button** **11** to activate the Fade-in/out or Wipe-in/out.

**To Deactivate The Selected Effect . . .**

..... select "OFF" in step 4.

## IMPORTANT

Some Fade/Wipe Effects cannot be used with certain modes of Program AE with special effects (pg. 27). If an unusable Fade/Wipe Effect is selected, its indicator blinks or goes out.

### NOTE:

You can extend the length of a Fade or Wipe by pressing and holding the **Recording Start/Stop Button** **11**.

### **FADER — WHITE**

Fade in or out with a white screen.

### **FADER — BLACK**

Fade in or out with a black screen.

### **FADER — B.W**

Fade in to a color screen from a black and white screen, or fade out from color to black and white.

### **WIPE — CORNER**

Wipe in on a black screen from the upper right to the lower left corner, or wipe out from lower left to upper right, leaving a black screen.

### **WIPE — WINDOW**

The scene starts in the center of a black screen and wipes in toward the corners, or comes in from the corners, gradually wiping out to the center.

### **WIPE — SLIDE**

Wipe in from right to left, or wipe out from left to right.

### **WIPE — DOOR**

Wipe in as the two halves of a black screen open to the left and right, revealing the scene, or wipe out and the black screen reappears from left and right to cover the scene.

### **WIPE — SCROLL**

The scene wipes in from the bottom to the top of a black screen, or wipes out from top to bottom, leaving a black screen.

### **WIPE — SHUTTER**

Wipe in from the center of a black screen toward the top and bottom, or wipe out from the top and bottom toward the center leaving a black screen.

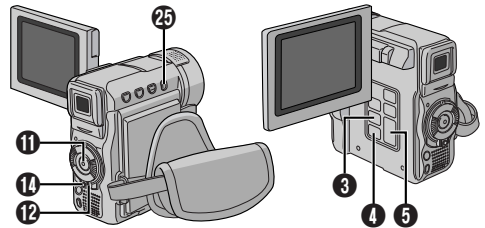

Refer to the diagrams on page 52 and 54 for the controls, indications, indicators and connectors mentioned.

## Snapshot (For Tape Recording)

This feature lets you record still images that look like photographs onto a tape.

### SNAPSHOT MODE SELECTION

- 1 Set the **VIDEO/MEMORY Switch** (25) to "VIDEO", then set the Power Switch (12) to "M" while pressing down the Lock Button (11) located on the switch. Open the LCD monitor fully or pull out the viewfinder fully.
- 2 Press **MENU** (4). The Menu Screen appears.
- 3 Press + or - (5) to select "A (CAMERA)", then press **SELECT/SET** (3).
- 4 Press + or - (5) to select "SNAP MODE", then press **SELECT/SET** (3).
- 5 Press + or - (5) to select the desired Snapshot mode, then press **SELECT/SET** (3). Press + or - (5) to select "RETURN" and press **SELECT/SET** (3) twice. The Menu Screen closes.



FULL

Snapshot mode with no frame



NEGA  
(GR-DX300 only)

Nega mode



PIN-UP

Pin-Up mode



FRAME

Snapshot mode with frame

There is the sound effect of a shutter closing.

### SNAPSHOT RECORDING

- 1 Press **SNAPSHOT** (9). "PHOTO" ■ appears while the snapshot is being taken.

If you press during Record-Standby . . .

..... "PHOTO" ■ appears and a still image will be recorded for approx. 6 seconds, then the camcorder re-enters the Record-Standby mode.

If you press during Recording . . .

..... "PHOTO" ■ appears and a still image will be recorded for approx. 6 seconds, then the normal recording resumes.

- Regardless of the Power Switch (12) position ("A" or "M"), Snapshot recording takes place using the selected Snapshot mode.

#### Motor Drive Mode

Keeping **SNAPSHOT** (9) pressed provides an effect similar to serial photography. (Interval between still images: approx. 1 second)

### NOTES:

- To remove the shutter sound, [BEEP] on pg. 34.
- If Snapshot recording is not possible, "PHOTO" ■ blinks when **SNAPSHOT** (9) is pressed.
- If Program AE with special effects (27 pg. 27) is engaged, certain modes of Program AE with special effects are disabled during Snapshot recording. In such a case, the icon blinks.
- If **SNAPSHOT** (9) is pressed when "DIS" is set to "ON" (27 pg. 33), the Stabilizer will be disabled.
- The Motor Drive mode is disabled when "REC SELECT" is set to "→ [CO] / → [M]" in the Menu Screen (27 pg. 35).
- If "REC SELECT" is set to "→ [CO] / → [M]" in the DSC Menu Screen, still images are recorded on the memory card as well (640 x 480 pixels).
- During playback as well, all snapshot modes except Nega mode are available when "[CO] → [M] COPY" is set to "OFF" in the Menu Screen (27 pg. 35).
- During Snapshot recording, the image displayed in the viewfinder may be partially missing. However, there is no effect in the recorded image.
- When a cable is connected to the S/AV connector, the shutter sound is not heard from the speaker, however it is recorded onto the tape.

### Auto Focus

The camcorder's Full Range AF system offers continuous shooting ability from close-up (as close as approx. 5 cm (2") to the subject) to infinity.

However, correct focus may not be obtainable in the situations listed below (in these cases use manual focusing):

- When two subjects overlap in the same scene.
- When illumination is low.\*
- When the subject has no contrast (difference in brightness and darkness), such as a flat, one-color wall, or a clear, blue sky.\*
- When a dark object is barely visible in the viewfinder.\*
- When the scene contains minute patterns or identical patterns that are regularly repeated.
- When the scene is affected by sunbeams or light reflecting off the surface of a body of water.
- When shooting a scene with a high-contrast background.

\* The following low-contrast warnings appear blinking:

▲, ◀, ▶ and ♀

### NOTES:

- If the lens is smeared or blurred, accurate focusing is not possible. Keep the lens clean, wiping with a piece of soft cloth if it gets dirty. When condensation occurs, wipe with a soft cloth or wait for it to dry naturally.
- When shooting a subject close to the lens, zoom out first (27 pg. 13). If zoomed-in in the auto focus mode, the camcorder may automatically zoom out depending on the distance between the camcorder and the subject. This will not occur when "TELE MACRO" (27 pg. 33) is activated.

Refer to the diagrams on page 52 and 54 for the controls, indications, indicators and connectors mentioned.

To obtain correct focus.

**1** If you are using the viewfinder, you should already have made the necessary viewfinder adjustments (☞ pg. 8).

**2** Set the Power Switch **12** to “**M**” while pressing down the Lock Button **11** located on the switch, then press **FOCUS 24** (☞ pgs. 52 and 53). The manual focus indicator appears.

**3** To focus on a farther subject, press + **5**. “**▶**” ■ appears and blinks.  
To focus on a nearer subject, press – **5**. “**◀**” ■ appears and blinks.

**4** Press **SELECT/SET 3**. Focus adjustment is complete.

To reset to Auto Focus, press **FOCUS 24** twice or set the Power Switch **12** to “**A**”.

If **FOCUS 24** is pressed once, the camcorder will enter the focus adjustment mode again.

#### NOTES:

- Be sure to focus the lens in the maximum telephoto position when you use the Manual Focus mode. If you focus in on a subject in the wide-angle position, sharply focused images cannot be obtained when zoomed up because the depth-of-field is reduced at longer focal lengths.
- When the focus level cannot be adjusted any further or closer, “**▲**” or “**●**” will blink.

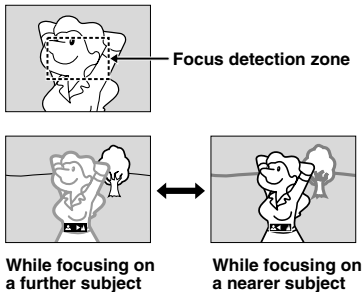

Manual exposure adjustment is recommended in the following situations:

- When shooting using reverse lighting or when the background is too bright.
- When shooting on a reflective natural background such as at the beach or when skiing.
- When the background is overly dark or the subject light.

**1** Set the Power Switch **12** to “**M**” while pressing down the Lock Button **11** located on the switch. Open the LCD monitor fully or pull out the viewfinder fully.

**2** Press **MENU 4**. The Menu Screen appears.

**3** Press + or – **5** to select “**E3** (EXPOSURE)”, then press **SELECT/SET 3**.

**4** Press + or – **5** to select “**MANUAL**”, then press **SELECT/SET 3**. The Menu Screen disappears. The exposure control indicator appears.

**5** Press + **5** to brighten the image, or – **5** to darken the image. (maximum  $\pm 6$ )

**6** Press **SELECT/SET 3**. Exposure adjustment is complete.

#### To Return To Automatic Exposure Control . . .

..... select “**AUTO**” in step 4. Or, set the Power Switch **12** to “**A**”.

#### To Brighten The Subject Quickly . . .

..... press **BACKLIGHT 22**. **22** ■ is displayed and the subject is brightened. If pressed again, **22** ■ disappears and the brightness returns to the previous level.

- +3 exposure has the same effect as the **BACKLIGHT Button 22**.
- Using **BACKLIGHT 22** may cause the light around the subject to become too bright and the subject to become white.
- Backlight compensations is also available when the Power Switch **12** is set to “**A**”.

#### NOTE:

You cannot use the manual exposure control at the same time with backlight, spotlight (☞ pg. 27) compensation and “**SNOW**” (☞ pg. 27).

Refer to the diagrams on page 52 and 54 for the controls, indications, indicators and connectors mentioned.

## Iris Lock

Use this function in the following situations:

- When shooting a moving subject.
- When the distance to the subject changes (so its size in the LCD monitor or the viewfinder changes), such as when the subject is backing away.
- When shooting on a reflective natural background such as at the beach or when skiing.
- When shooting objects under a spotlight.
- When zooming.

When the subject is close, keep the iris locked. Even when the subject moves away from you, the image will not darken or brighten.

**Before the following steps, perform steps 1 through 4 of “Exposure Control”** (☞ pg. 30).

**5** Adjust zoom so that the subject fills the LCD monitor or the viewfinder, then press and hold **SELECT/SET** **3** for over 2 seconds. The exposure control indicator **■** and “**L**” **■** appear. Press **SELECT/SET** **3**. “**L**” **■** changes to “**L**” and the iris is locked.

**To Return To Automatic Iris Control . . .**

..... press + or – **5** to display “AUTO” then press **SELECT/SET** **3** in step 4. The exposure control indicator **■** and “**L**” **■** disappear. Or, set the Power Switch **12** to “**A**”.

**To Lock The Exposure Control And The Iris . . .**

..... after step 4 of “Exposure Control” (☞ pg. 30), adjust the exposure pressing + or – **5**. Then lock the iris in step 5 of “Iris Lock”. For automatic locking, press + or – **5** to select “AUTO”, then press **SELECT/SET** **3** in step 4. The iris becomes automatic after about 2 seconds.

### Iris

Like the pupil of the human eye, it contracts in well-lit environments to keep too much light from entering, and dilates in dim environments to allow in more light.

## White Balance Adjustment

A term that refers to the correctness of color reproduction under various lighting. If the white balance is correct, all other colors will be accurately reproduced.

The white balance is usually adjusted automatically. However, more advanced camcorder operators control this function manually to achieve a more professional color/tint reproduction.

**1** Set the Power Switch **12** to “**M**” while pressing down the Lock Button **11** located on the switch. Open the LCD monitor fully or pull out the viewfinder fully.

**2** Press **MENU** **1**. The Menu Screen appears.

**3** Press + or – **5** to select “**W.BALANCE**”, then press **SELECT/SET** **3**.

**4** Press + or – **5** to select the desired mode.

“**AUTO**”: White balance is adjusted automatically (factory preset).

“**MWB**”: White balance is set manually.

“**FINE**”: Outdoors on a sunny day.

“**CLOUD**”: Outdoors on a cloudy day.

“**HALOGEN**”: A video light or similar type of lighting is used.

**5** Press **SELECT/SET** **3**. Selection is complete. Press **SELECT/SET** **3** again. The Menu Screen closes and the selected mode indicator except “**AUTO**” appears.

**To Return To Automatic White Balance . . .**

..... select “**AUTO**” in step 4. Or, set the Power Switch **12** to “**A**”.

### NOTE:

White balance cannot be used when Sepia or Monotone (☞ pg. 27) is activated.

## Manual White Balance Operation

Perform Manual White Balance when shooting under various types of lighting.

**1** Follow steps 1 through 4 of the white balance adjustment, and select “**MWB**”.

**2** Hold a sheet of plain white paper in front of the lens. Adjust zoom or position yourself so that the white paper fills the screen.

**3** Press **SELECT/SET** **3** until **MWB** begins blinking rapidly. When the setting is completed, **MWB** resumes normal blinking.

**4** Press **SELECT/SET** **3** twice. The Menu Screen closes and the Manual White Balance indicator **MWB** **■** is displayed.

### NOTES:

- In step 2, it may be difficult to focus on the white paper. In such a case, adjust focus manually (☞ pg. 30).
- A subject can be shot under various types of lighting conditions indoors (natural, fluorescent, candlelight, etc.). Because the color temperature is different depending on the light source, the subject tint will differ depending on the white balance settings. Use this function for a more natural result.
- Once you adjust white balance manually, the setting is retained even if the power is turned off or the battery removed.

Refer to the diagrams on page 52 and 54 for the controls, indications, indicators and connectors mentioned.

## For Recording Menu

This camcorder is equipped with an easy-to-use, on-screen menu system that simplifies many of the more detailed camcorder settings (☞ pg. 32 – 35).

**1** Set the Power Switch **12** to “**M**” while pressing down the Lock Button **11** located on the switch. Open the LCD monitor fully or pull out the viewfinder fully.

**2** Press **MENU** **1**. The Menu Screen appears.

**3** Press + or – **5** to select the desired function menu, and press **SELECT/SET** **3**.

**4** Function menu setting depends on the function.

If you have selected “**WIPE/FADER**”, “**PROGRAM AE**”, “**EXPOSURE**” or “**W. BALANCE**” . . .

..... see the column on the right.

If you have selected “**A CAMERA**”, “**MANUAL**”, “**SYSTEM**”, “**CAMERA DISPLAY**” or “**DSC**” . . .

..... go to step 5.

**5** Press + or – **5** to select the desired function and press **SELECT/SET** **3**. The Sub Menu appears. Then, press + or – **5** to select the parameter, and press **SELECT/SET** **3**. Selection is complete.

**6** Press + or – **5** to select “**RETURN**” and press **SELECT/SET** **3** twice. The Menu Screen closes.

• The **END** icon represents “END”.

### NOTE:

When the Menu Screen is left on for a couple of minutes, a residual image may be left on the screen and it may take several seconds for the residual image to disappear. This is not due to any defect of the unit.

## **WIPE/FADER**

Refer to “Fade/Wipe Effects” (☞ pg. 28).

## **PROGRAM AE**

Refer to “Program AE With Special Effects” (☞ pg. 27).

## **EXPOSURE**

Refer to “Exposure Control” and “Iris Lock” (☞ pg. 30, 31).

## **W.BALANCE**

Refer to “White Balance Adjustment” and “Manual White Balance Operation” (☞ pg. 31).

## **A CAMERA**

Settings made in the “**A CAMERA**” Menu remain effective whether the Power Switch **12** is set to “**A**” or “**M**”. However, the menu settings can be changed only when the Power Switch **12** is set to “**M**”.

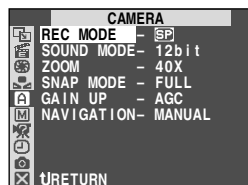

### **REC MODE**

Allows you to set the tape recording mode ([SP] or LP) depending on your preference (☞ pg. 10).

### **SOUND MODE**

**[12bit]:** Enables tape recording of stereo sound on four separate channels, and is recommended for use when performing audio dubbing. (Equivalent to the 32 kHz mode of previous models)

**16bit:** Enables tape recording of stereo sound on two separate channels. (Equivalent to the 48 kHz mode of previous models)

### **ZOOM**

**10X\*/16X\*\*:** When set to “10X\*/16X\*\*” while using digital zoom, the zoom magnification will reset to 10X\*/16X\*\* since digital zoom will be disengaged.

**[40X]:** Allows you to use the Digital Zoom. By digitally processing and magnifying images, zooming is possible from 10X\*/16X\*\* (the optical zoom limit), to a maximum of 40X digital magnification.

**500X\*/700X\*\*:** Allows you to use the Digital Zoom. By digitally processing and magnifying images, zooming is possible from 10X\*/16X\*\* (the optical zoom limit), to a maximum of 500X\*/700X\*\* digital magnification.

\* GR-DX300 only.

\*\* GR-DX95/DX75 only.

[ ] = Factory-preset

Refer to the diagrams on page 52 and 54 for the controls, indications, indicators and connectors mentioned.



## SNAP MODE

Refer to “Snapshot (For Tape Recording)” (☞ pg. 29).

## GAIN UP

**OFF:** Allows you to shoot dark scenes with no picture brightness adjustment.

**[AGC]:** The overall appearance may be grainy, but the image is bright.

**AUTO  $\rightarrow$  A:** The shutter speed is automatically adjusted (1/30 — 1/200 sec.). Shooting a subject in low or poor lighting at 1/30 sec. shutter speed provides a brighter image than in the AGC mode, but the subject’s movements are not smooth or natural. The overall appearance may be grainy. While the shutter speed is being automatically adjusted, “ $\rightarrow$  A” is displayed.

## NAVIGATION

Refer to “NAVIGATION Function” (☞ pg. 21, 22).

## MANUAL

The “MANUAL” settings are effective only when the Power Switch **1** is set to “M”.

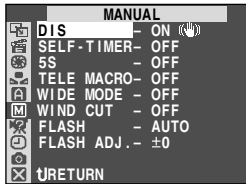

## DIS

**OFF:** To turn off this function.

**[ON (👁)]:** To compensate for unstable images caused by camera-shake, particularly at high magnification.

## NOTES:

- Accurate stabilization may not be possible if hand shake is excessive, or under the following conditions:
  - When shooting subjects with vertical or horizontal stripes.
  - When shooting dark or dim subjects.
  - When shooting subjects with excessive backlighting.
  - When shooting scenes with movement in various directions.
  - When shooting scenes with low-contrast backgrounds.
- Switch off this mode when recording with the camcorder on a tripod.
- The “👁” indicator **■** blinks or goes out if the Stabilizer cannot be used.

## SELF-TIMER (GR-DX300 only)

Refer to “Self-Timer” (☞ pg. 26).

## 5S (GR-DX300 only)

**[OFF], 5S:** Refer to “5-Second Recording” (☞ pg. 26).

**Anim.:** Allows you to record a few frames only. By using an inanimate object and changing its position between shots, you can record the subject as though it is moving (☞ pg. 26).

## TELE MACRO

**[OFF]:** To turn off this function.

**ON:** Usually the distance to a subject where the lens is in focus depends on the zoom magnification. Unless there is a distance more than 1m (3.3 ft) to the subject, the lens is out of focus at the maximum telephoto setting. When set to “ON”, you can shoot a subject as large as possible at a distance of approx. 60 cm (2 ft).

- Depending on the zoom position, the lens may go out of focus.

## WIDE MODE

**[OFF]:** Records with no change in the screen ratio. For playback on a TV with a normal screen ratio.

**CINEMA  $\square$ :** Inserts black bands at the top and bottom of the screen. During playback on wide-screen TVs, the black bands at the top and bottom of the screen are cut and the screen ratio becomes 16:9.  $\square$  3 appears. When using this mode, refer to your wide-screen TV’s instruction manual. During playback/recording on 4:3 TVs/LCD monitor/viewfinder, black bands are inserted at the top and bottom of the screen and the image appears like a letterboxed 16:9 movie.

- The “CINEMA” mode is effective only when the VIDEO/MEMORY Switch **2** is set to “VIDEO”.

**SQUEEZE  $\square$ :** For playback on TVs with an aspect ratio of 16:9. Naturally expands the image to fit the screen without distortion.  $\square$  appears. When using this mode, refer to your wide-screen TV’s instruction manual. During playback/recording on 4:3 TVs/LCD monitor/viewfinder, the image is elongated vertically.

- The “SQUEEZE” mode is effective only when the VIDEO/MEMORY Switch **2** is set to “VIDEO”.

**D.WIDE  $\square$  (GR-DX300 only):  $\square$  appears.** The zoom range is extended beyond the maximum optical zoom wide angle range. This mode’s wide angle setting is equivalent to using a 0.7X wide conversion lens. Zooming is possible from 0.7X to 10X. This mode is suitable for shooting in a small room.

- The “D.WIDE” mode is effective only when the VIDEO/MEMORY **2** Switch is set to “VIDEO”.

## WIND CUT

**[OFF]:** Disengages the function which cuts down on noise created by wind.

**ON  $\square$ :** Helps cut down on noise created by wind. “ $\square$ ” appears. The quality of the sound will change. This is normal.

## FLASH

Refer to “Snapshot Flash” (☞ pg. 25).

## FLASH ADJ.

Refer to “Flash Brightness Adjustment” (☞ pg. 25).

[ ] = Factory-preset

**Refer to the diagrams on page 52 and 54 for the controls, indications, indicators and connectors mentioned.**

## SYSTEM

"SYSTEM" functions which are set when the Power Switch **(P)** is set to "M" are also applied when the Power Switch **(P)** is set to "PLAY" (☞ pg. 35).

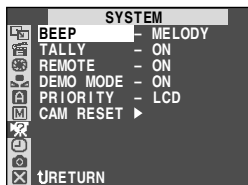

### BEEP

**OFF:** Even though not heard while shooting, shutter sound is recorded on the tape.

**BEEP:** The beep sounds when the power is turned on or off, and at the beginning and end of recording. Also to activate the shutter sound effect (☞ pg. 17, 29).

**[MELODY]:** Instead of a beep, a melody sounds when any operation is performed. It also activates the shutter sound effect (☞ pg. 17, 29).

### TALLY

**OFF:** The tally lamp remains off at all times.

**[ON]:** The tally lamp comes on to signal the start of recording.

### REMOTE

**OFF:** Disables the camcorder from receiving the remote control's beam signals. The camcorder cannot be operated by the remote control.

**[ON]:** Enables the camcorder to receive the remote control's beam signals.

### DEMO MODE

**OFF:** Automatic demonstration will not take place.

**[ON]:** Demonstrates certain functions such as Program AE with special effects, etc., and can be used to confirm how these functions operate. Demonstration starts in the following cases:

- When the Menu Screen is closed after "DEMO MODE" is turned "ON".
- With "DEMO MODE" set to "ON", if there is no operation for about 3 minutes after the Power Switch **(P)** is set to "A" or "M".

Performing any operation during the demonstration stops the demonstration temporarily. If no operation is performed for more than 3 minutes after that, the demonstration will resume.

### NOTES:

- If a tape is in the camcorder, the demonstration cannot be turned on.
- "DEMO MODE" remains "ON" even if the camcorder power is turned off.
- If "DEMO MODE" remains "ON", some functions will not be available. After viewing demo, set to "OFF".

Refer to the diagrams on page 52 and 54 for the controls, indications, indicators and connectors mentioned.

## PRIORITY

**[LCD]:** When the LCD monitor is fully open, even if the viewfinder is pulled out, the image is displayed only on the LCD monitor; it will not be displayed in the viewfinder.

**FINDER:** When the viewfinder is pulled out, even if the LCD monitor is fully open, the image is displayed only in the viewfinder; it will not be displayed on the LCD monitor.

### CAM RESET

**EXECUTE:** Resets all settings to the factory-preset.

**[RETURN]:** Does not reset all settings to the factory-preset.

## CAMERA DISPLAY

- Settings made in the "CAMERA DISPLAY" Menu are effective only for video shooting.
- Settings made in the "CAMERA DISPLAY" Menu remain effective even when the Power Switch **(P)** is set to "A". However, the menu settings can be changed only when the Power Switch **(P)** is set to "M".



### ON SCREEN

**LCD:** Keeps the camcorder's display (except the date, time and time code) from appearing on the connected TV screen.

**[LCD/TV]:** Makes the camcorder's display appear on screen when the camcorder is connected to a TV.

### DATE/TIME

**OFF:** The date/time does not appear.

**[AUTO]:** Displays the date/time for approx. 5 seconds in the following cases:

- When the Power Switch **(P)** is set from "OFF" to "A" or "M".
- When tape playback starts. The camcorder displays the date/time when scenes are recorded.
- When the date is changed during tape playback.

**ON:** The date/time is always displayed.

- The date indication can also be turned on/off by pressing the **DISPLAY** Button **(F)** on the remote control.

[ ] = Factory-preset

## TIME CODE

**[OFF]:** Time code is not displayed.

**ON:** Time code is displayed on the camcorder and on the connected TV. Frame numbers are not displayed during recording.

## CLOCK ADJ.

Allows you to set the current date and time (ⓘ pg. 10).

## DSC



## QUALITY , IMAGE SIZE

Refer to "Picture Quality/Image Size Setting" (ⓘ pg. 11).

## REC SELECT

[➡ **📷**]: When Snapshot recording is performed with the **VIDEO/MEMORY** Switch **25** set to "VIDEO", still images are recorded only onto the tape.

➡ **📷** / ➡ **📷**: When Snapshot recording is performed with the **VIDEO/MEMORY** Switch **25** set to "VIDEO", still images are recorded not only onto the tape but also on the memory card (640 x 480 pixels). In this mode, the "SNAP MODE" selection in the CAMERA Menu is also applicable to memory card recording.

## For Playback Menu

The following procedure applies to all except Synchro Comp (ⓘ pg. 43).

- 1 Set the **VIDEO/MEMORY** Switch **25** to "VIDEO", then set the Power Switch **12** to "PLAY" while pressing down the Lock Button **11** located on the switch.
- 2 Press **MENU** **4**. The Menu Screen appears.
- 3 Press + or - **5** to select the desired function menu, and press **SELECT/SET** **3**.
- 4 Press + or - **5** to select the desired function, and press **SELECT/SET** **3** to display the Sub Menu.
- 5 Press + or - **5** to select the desired parameter and press **SELECT/SET** **3**. Selection is complete.
- 6 Press + or - **5** to select "RETURN" and press **SELECT/SET** **3** twice to close the Menu Screen.

Refer to the diagrams on page 52 and 54 for the controls, indications, indicators and connectors mentioned.

## VIDEO



**SOUND MODE** ..... ⓘ pg. 36, "Playback Sound".

**12bit MODE** ..... ⓘ pg. 36, "Playback Sound".

**SYNCHRO** ..... ⓘ pg. 43, "For More Accurate Editing".

## REC MODE

Allows you to set the tape recording mode ([SP] or LP) depending on your preference (ⓘ pg. 10).

It is recommended you use "REC MODE" in the "VIDEO" Menu when using this camcorder as a recorder during dubbing (ⓘ pg. 37, 38).

- "REC MODE" can be set when the Power Switch **12** is set to "PLAY" or "M" (ⓘ pg. 10, 32).

## COPY

**ON:** Enables dubbing of images recorded on a tape to a memory card (ⓘ pg. 23).

**[OFF]:** Enables snapshots to be taken during tape playback.

## NAVI. DEL.

Refer to "NAVIGATION Function" (ⓘ pg. 21, 22).

## S/AV INPUT

**A/V. IN:** Enables audio/video signal input from the S/AV connector (ⓘ pg. 37).

**S. IN:** Enables S-Video/audio signal input from the S/AV connector (ⓘ pg. 37).

**[OFF]:** Enables audio/video signal output to a TV, VCR, etc. via the S/AV connector (ⓘ pg. 16, 37).

- When "S/AV INPUT" is set to "A/V. IN" or "S. IN", camcorder playback cannot be viewed on the AV output.

## SYSTEM

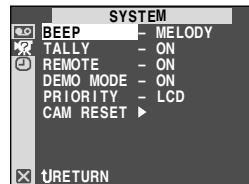

Each setting is linked with "SYSTEM", which appears when the Power Switch **12** is set to "M" (ⓘ pg. 34).

The parameters are the same as in the description on pg. 34.

[ ] = Factory-preset

## VIDEO DISPLAY

- Settings made in the “VIDEO DISPLAY” Menu are effective only for tape playback.



### ON SCREEN

**OFF:** Camcorder's display (except the date, time and time code) is not shown on LCD or connected TV.

**[LCD]:** Camcorder's display is shown only on LCD and not on connected TV (except the date, time and time code).

**LCD/TV:** Camcorder's display is shown on both LCD and connected TV.

### DATE/TIME , TIME CODE

Refer to “CAMERA DISPLAY” on page 34, 35. The factory-preset of “DATE/TIME” in the “VIDEO DISPLAY” Menu is “OFF”.

## Playback Sound

During tape playback, the camcorder detects the sound mode in which the recording was made, and plays the sound back. Select the type of sound to accompany your playback picture. According to the menu access explanation on pg. 35, select “SOUND MODE” or “12bit MODE” from the Menu Screen and set it to the desired parameter.

### SOUND MODE

**[STEREO ]:** Sound is output on both “L” and “R” channels in stereo.

**SOUND L ]:** Sound from the “L” channel is output.

**SOUND R ]:** Sound from the “R” channel is output.

### 12bit MODE

**MIX:** Original and dubbed sounds are combined and output in stereo on both “L” and “R” channels.

**[SOUND 1]:** Original sound is output on both “L” and “R” channels in stereo.

**SOUND 2:** Dubbed sound is output on both “L” and “R” channels in stereo.

[ ] = Factory-preset

## NOTES:

- The camcorder cannot detect the sound mode in which the recording was made during fast-forward or rewind. During playback the sound mode is displayed in the upper left corner.
- The “SOUND MODE” setting is available for both 12-bit and 16-bit sound. (In previous models' functions, “12-bit” is called “32 kHz” and “16-bit” is called “48 kHz”.)

## Display

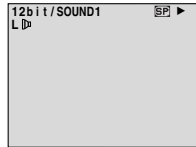

**ON SCREEN setting:**  
For playback sound, tape speed and tape running.

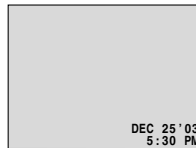

**DATE/TIME setting:**  
For date/time.



**TIME CODE setting:**  
For time code.

\* 30 frames = 1 second

Refer to the diagrams on page 52 and 54 for the controls, indications, indicators and connectors mentioned.

## Dubbing To Or From A VCR

### To Use This Camcorder As A Player

- Following the illustration, connect the camcorder and the VCR. Also refer to pg. 16.
- Set the **VIDEO/MEMORY Switch** (25) to "VIDEO", then set the camcorder's Power Switch (12) to "**PLAY**" while pressing down the Lock Button (14) located on the switch, turn on the VCR's power, and insert the appropriate cassettes in the camcorder and the VCR.
- Engage the VCR's AUX and Record-Pause modes.
- Engage the camcorder's Play mode to find a spot just before the edit-in point. Once it is reached, press **▶/II** (11) on the camcorder.
- Press **▶/II** (11) on the camcorder and engage the VCR's Record mode.
- Engage the VCR's Record-Pause mode and press **▶/II** (11) on the camcorder.
- Repeat steps 4 through 6 for additional editing, then stop the VCR and camcorder when finished.

#### NOTES:

- As the camcorder starts to play your footage it will appear on your TV. This will confirm the connections and the AUX channel for dubbing purposes.
- Before you start dubbing, make sure that the indications do not appear on the connected TV. If they do, they are being recorded onto the new tape.

#### To choose whether or not the following displays appear on the connected TV . . .

- Date/Time**  
..... set "DATE/TIME" to "AUTO", "ON" or "OFF" in the Menu Screen (ⓘ pg. 34, 36).  
Or, press **DISPLAY** (17) on the remote control to turn on/off the date indication.
- Time Code**  
..... set "TIME CODE" to "ON" or "OFF" in the Menu Screen (ⓘ pg. 35, 36).
- Indications other than date/time and time code  
..... set "ON SCREEN" to "LCD", "LCD/TV" or "OFF" in the Menu Screen (ⓘ pg. 34, 36).

### To Use This Camcorder As A Recorder

- Set the **VIDEO/MEMORY Switch** (25) to "VIDEO", then set the camcorder's Power Switch (12) to "**PLAY**" while pressing down the Lock Button (14) located on the switch.
- Set "S/AV INPUT" to "A/V. IN" or "S. IN" and set "REC MODE" to "SP" or "LP" (ⓘ pg. 35).
- Connect the cables as shown in the illustration and load a cassette to record on.

- Press **START/STOP** (13) on the remote control to engage the Record-Pause mode. "**A/V.IN**" or "**S.IN**" appears on the screen.
- Press **START/STOP** (13) on the remote control to start recording. **▶** rotates.
- Press **START/STOP** (13) on the remote control again to engage the Record-Pause mode. **▶** stops rotating.

#### NOTES:

- To use an output cable adapter (commercially available), refer to its instructions.
- After dubbing, set "S/AV INPUT" back to "OFF".
- Analog signals can be converted to digital signals with this procedure.
- It is also possible to dub from another camcorder.

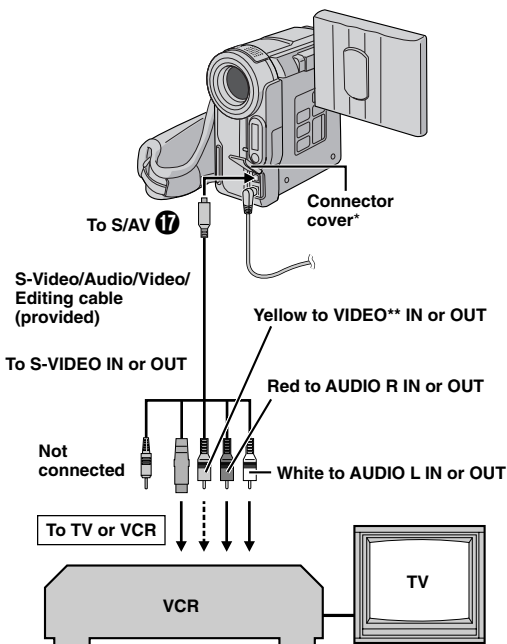

\* When connecting the cables, open this cover.

\*\* Connect when the S-Video connection is not used.

Refer to the diagrams on page 52 and 54 for the controls, indications, indicators and connectors mentioned.

## Dubbing To Or From A Video Unit Equipped With A DV Connector (Digital Dubbing)

It is also possible to copy recorded scenes from this camcorder onto another video unit equipped with a DV connector. Since a digital signal is sent, there is little if any image or sound deterioration.

### To Use This Camcorder As A Player

**1** Make sure all units are turned off. Connect this camcorder to a video unit equipped with a DV input connector using a DV cable as shown in the illustration.

**2** Set this camcorder's **VIDEO/MEMORY Switch** (25) to "VIDEO", then the **Power Switch** (12) to "PLAY" while pressing down the **Lock Button** (14) located on the switch, turn on the video unit's power, and insert the appropriate cassettes in this camcorder and the video unit.

**3** Press **▶** (11) to play back the source tape.

**4** While watching the playback on the monitor, engage the DV connector-equipped video unit's record mode from the spot on the source tape you want to begin recording.

### NOTES:

- It is recommended to use the AC Adapter as the power supply instead of the battery pack (ⓘ pg. 7).
- If the remote control is used when both the player and recorder are JVC video units, both units will perform the same operation. To prevent this from happening, press the buttons on both units.
- If a blank portion or disturbed image is played back on the player during dubbing, the dubbing may stop so that an unusual image is not dubbed.
- Even though the DV cable is connected correctly, sometimes the image may not appear in step 4. If this occurs, turn off the power and make connections again.
- If "Playback Zoom" (ⓘ pg. 13, 39), "Playback Special Effects" (ⓘ pg. 39) or "Snapshot" is attempted during playback, only the original playback image recorded on the tape is output from the DV connector (20).
- When using a DV cable, be sure to use the optional JVC VC-VDV204U DV cable.

### To Use This Camcorder As A Recorder

**1.** Set this camcorder's **VIDEO/MEMORY Switch** (25) to "VIDEO", then the **Power Switch** (12) to "PLAY" while pressing down the **Lock Button** (14) located on the switch.

**2.** Set "REC MODE" to "SP" or "LP" in the Menu Screen (ⓘ pg. 35).

**3.** Connect the DV cable as shown in the illustration and load a cassette to record on.

**4.** Press **START/STOP** (18) on the remote control to engage the Record-Pause mode. "DV.IN" appears on the screen.

**5.** Press **START/STOP** (18) on the remote control to start recording.  rotates.

**6.** Press **START/STOP** (18) on the remote control again to engage the Record-Pause mode.  stops rotating.

### NOTES:

- Digital Dubbing is performed in the sound mode recorded on the original tape, regardless of the current "SOUND MODE" setting (ⓘ pg. 32).
- During Digital Dubbing, incoming signals cannot be output through the video or audio connectors if they are copy-guarded.

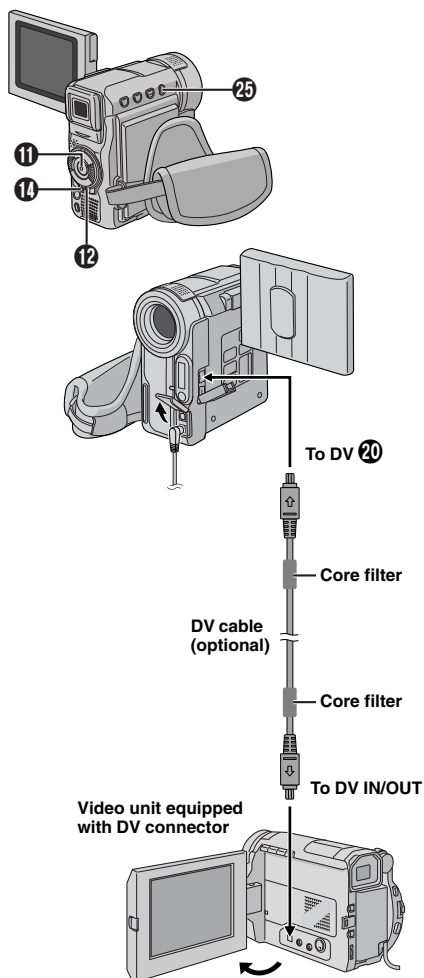

Refer to the diagrams on page 52 and 54 for the controls, indications, indicators and connectors mentioned.

Make sure "REMOTE" in the SYSTEM Menu is set to "ON" (☞ pg. 34) and the remote control is pointed at the remote sensor 15. The transmitted beam's approximate effective distance for indoor use is 5m.

## Playback Special Effects

To allow you to add creative effects to the playback image.

- 1 To start playback, press **PLAY** (▶) 63.
- 2 Point the remote control at the camcorder's remote sensor and press **EFFECT** 41. The **PLAYBACK EFFECT Select Menu** appears.
- 3 Move the highlight bar to the desired effect by pressing **EFFECT** 41. The selected function is activated and after 2 seconds the menu disappears.
  - To deactivate the selected effect, press **EFFECT ON/OFF** 43 on the remote control. Pressing it again re-activates the selected effect.
  - To change the selected effect, repeat from step 2 above.

### NOTE:

The effects that can be used during playback are Classic Film, Monotone, Sepia and Strobe. The effects work the same in playback as they did in recording. Refer to page 27 for more information.

## Slow-Motion Playback

To allow slow-speed search in either direction during tape playback.

- 1 To change from normal to Slow-Motion Playback, press **SLOW** (◀) 40 or (▶) 39 more than approx. 2 seconds. After approx. 5 minutes (approx. 20 seconds with an 80-minute cassette) in Slow Rewind or approx. 5 minutes in Slow Forward, normal playback resumes.
  - To stop Slow-Motion Playback, press **PLAY** (▶) 63.

### NOTES:

- You can also engage Slow-Motion Playback from Still Playback by pressing **SLOW** 40 39 more than approx. 2 seconds.
- During Slow-Motion Playback, due to digital image processing, the picture may take on a mosaic effect.
- After **SLOW** (◀) 40 or (▶) 39 is pressed and held, the still image may be displayed for a few seconds, followed by a blue screen for a few seconds. This is not a malfunction.
- There may be a small margin between the slow-motion playback start point you chose and the actual start point for Slow-Motion Playback.
- During Slow-Motion Playback, there will be disturbances in video and the picture may seem unstable, especially with steady images. This is not a malfunction.
- During Slow-Motion Playback, press **PAUSE** (||) 56 to pause playback.

## Playback Zoom

To magnify the recorded image up to 50X (GR-DX300)/44X (GR-DX95/DX75) at any time during playback.

- 1 Press **PLAY** (▶) 63 to find the scene of interest.
- 2 Press the Zoom Button **T** 45 or **W** 46 on the remote control. Make sure the remote control is pointed at the camcorder's remote sensor. Pressing **T** 45 zooms in.
- 3 You can move the image on screen around to find a particular portion of the picture. While holding down **SHIFT** 38, press ◀ (Left) 40, ▶ (Right) 39, ▲ (Up) 51 and ▼ (Down) 52.
  - To end zoom, press and hold **W** 46 until magnification returns to normal. Or, press **STOP** (■) 55 and then press **PLAY** (▶) 63.

### NOTES:

- Zoom can also be used during slow-motion and still playback.
- Due to digital image processing, the quality of the image may suffer.

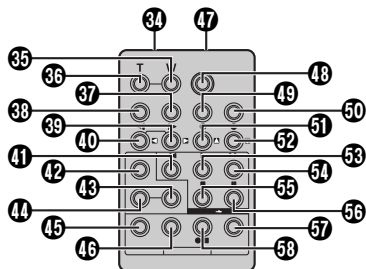

## Frame-By-Frame Playback

To allow frame-by-frame search during tape playback.

- 1 To change from normal to Frame-By-Frame Playback, press **SLOW** (▶) 39 repeatedly for forward or **SLOW** (◀) 40 repeatedly for reverse. Each time it is pressed, the frame is played back.

### NOTE:

You can also engage Frame-By-Frame Playback from Still Playback by pressing **SLOW** (◀) 40 or (▶) 39 repeatedly.

Normal playback



Press **T** 45



To move image, press ▶ (Right) 39 while keeping **SHIFT** 38 held down.

Refer to the diagrams on page 52 and 54 for the controls, indications, indicators and connectors mentioned.

## Audio Dubbing

The audio track can be customized only when recorded in the 12-bit mode (☞ pg. 32).

### NOTES:

- Audio Dubbing is not possible on a tape recorded in 16-bit audio, on a tape recorded in the LP mode or on a blank portion of a tape.
- To perform Audio Dubbing while watching on the television, make connections (☞ pg. 16).

**1** Play back the tape to locate the point where editing will start, then press **PAUSE (II) 56**.

**2** While holding **A.DUB (⊖) 92** on the remote control, press **PAUSE (II) 56**. "II" ■ and "MIC" appear.

**3** Press **PLAY (▶) 66**, then begin "narrating". Speak into the microphone.

- To pause dubbing, press **PAUSE (II) 56**.

**4** To end Audio Dubbing, press **PAUSE (II) 56**, then **STOP (■) 65**.

To hear the dubbed sound during playback . . .  
..... set "12bit MODE" to "SOUND 2" or "MIX" in the Menu Screen (☞ pg. 36).

### NOTES:

- Sound is not heard from the speaker during Audio Dubbing.
- When editing onto a tape that was recorded at 12-bit, the old and new soundtracks are recorded separately.
- If you dub onto a blank space on the tape, the sound may be disrupted. Make sure you only edit recorded areas.
- If feedback or howling occurs during TV playback, move the camcorder's microphone away from the TV, or turn down the TV's volume.
- If you change from 12-bit to 16-bit in mid-recording and then use the tape for Audio Dubbing, it is not effective from the point where 16-bit recording began.
- During Audio Dubbing, when the tape moves to scenes recorded in the LP mode, scenes recorded in 16-bit audio or a blank portion, Audio Dubbing stops (☞ pg. 56).
- To perform Audio Dubbing with a video unit connected to the camcorder's S/AV connector 17, first set "S/AV INPUT" to "A/V. IN" or "S. IN" in the Menu Screen (☞ pg. 35). "AUX" appears instead of "MIC".

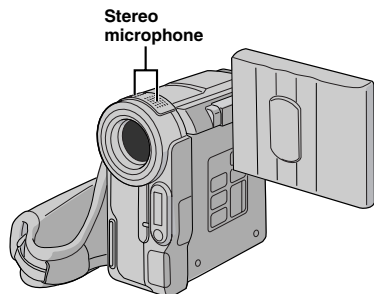

## Insert Editing

You can record a new scene into a previously recorded tape, replacing a section of the original recording with minimal picture distortion at the in and outpoints. The original audio remains unchanged.

### NOTES:

- Before performing the following steps, make sure that "TIME CODE" is set to "ON" in the Menu Screen (☞ pg. 35, 36).
- Insert Editing is not possible on a tape recorded in the LP mode or on a blank portion of a tape.
- To perform Insert Editing while watching in the television, make connections (☞ pg. 16).

**1** Play back the tape, locate the Edit-Out point and press **PAUSE (II) 56**. Confirm the time code at this point (☞ pg. 35, 36).

**2** Press **REW (◀) 41** until the Edit-In point is located, then press **PAUSE (II) 56**.

**3** Press and hold **INSERT (▷) 51** on the remote control, then press **PAUSE (II) 56**. "II" ■ and the Time Code (min.:sec.) appear and the camcorder enters Insert-Pause mode.

**4** Press **START/STOP 48** to begin editing.

- Confirm the insert at the time code you checked in step 1.
- To pause editing, press **START/STOP 48**. Press it again to resume editing.

**5** To end Insert Editing, press **START/STOP 48**, then **STOP (■) 7**.

### NOTES:

- Program AE with special effects (☞ pg. 27) can be used to spice up the scenes being edited during Insert Editing.
- During Insert Editing, the date and time information changes.
- If you perform Insert Editing onto a blank space on the tape, the audio and video may be disrupted. Make sure you only edit recorded areas.
- During Insert Editing, when the tape moves to scenes recorded in the LP mode or a blank portion, Insert Editing stops (☞ pg. 56).
- If a memory card is loaded and "NAVIGATION" is set to "ON", a NAVIGATION thumbnail image is stored in the memory card (☞ pg. 21).

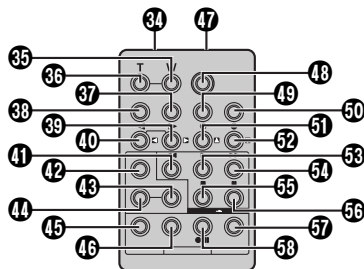

Refer to the diagrams on page 52 and 54 for the controls, indications, indicators and connectors mentioned.



Create edited videos easily using your camcorder as the source player. You can select up to 8 "cuts" for automatic editing, in any order you like. R.A.Edit is more easily performed when the MBR (Multi-Brand Remote) is set to operate with your brand of VCR (see VCR CODE LIST), but can also be performed by operating the VCR manually.

Before operation, make sure the batteries are installed in the remote control (☞ pg. 5).

**SET REMOTE/VCR CODE**

**1** Turn off the power to the VCR and point the remote towards the VCR's infrared sensor. Then, referring to the VCR CODE LIST, press and hold **MBR SET** (49), and enter the brand code.

The code is automatically set once you release **MBR SET** (49), and the VCR's power comes on.

**2** Make sure the VCR's power is on. Then, while holding **SHIFT** (30), press the button on the remote for the desired function. The functions the remote can control are PLAY, STOP, PAUSE, FF, REW and VCR REC STBY (you do not need to press **SHIFT** (30) for this one).

You are now ready to try Random Assemble Editing.

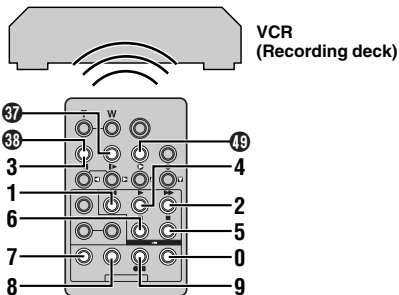

**Although the MBR is compatible with JVC VCRs and those of many other makers, it may not work with yours or may offer limited functions.**

**NOTES:**

- If the VCR's power does not come on in step 1, try another code from the VCR CODE LIST.
- Some brands of VCR do not come on automatically. In this case, turn the power on manually and try step 2.
- If the remote control is not able to control the VCR, use the controls on the VCR.
- When the remote control's batteries run out, the VCR brand you have set will be erased. In that case, replace the old battery with a new one to reset the VCR brand.

**MAKE CONNECTIONS**

Also refer to pg. 16 and 42.

**1** **A** A JVC VCR equipped with a remote pause connector . . .

.... connect the editing extension cable to the Remote PAUSE connector.

**B** A JVC VCR not equipped with a remote pause connector but equipped with an R.A.EDIT connector . . .

.... connect the editing extension cable to the R.A.EDIT connector.

**C** A VCR other than above . . .

.... connect the editing extension cable to the remote control's PAUSE IN connector (17).

**2** Insert a recorded tape into the camcorder. Set the VIDEO/MEMORY Switch (25) to "VIDEO", then set the Power Switch (12) to "PLAY" while pressing down the Lock Button (14) located on the switch.

**3** Turn the VCR power on, insert a recordable tape and engage the AUX mode (refer to the VCR's instructions).

**NOTES:**

Before Random Assemble Editing, make sure the indications do not appear on the TV monitor. If they do, they will be recorded onto the new tape.

**To choose whether or not the following displays appear on the connected TV . . .**

- Date/Time
  - .... set "DATE/TIME" to "AUTO", "ON" or "OFF" in the Menu Screen (☞ pg. 34, 36).
  - Or, press **DISPLAY** (47) on the remote control to turn on/off the date indication.
- Time Code
  - .... set "TIME CODE" to "ON" or "OFF" in the Menu Screen (☞ pg. 35, 36).
- Indications other than date/time and time code
  - .... set "ON SCREEN" to "LCD", "LCD/TV" or "OFF" in the Menu Screen (☞ pg. 34, 36).

Continued on next page.

**VCR CODE LIST**

VCR BRAND NAME	BRAND CODE	VCR BRAND NAME	BRAND CODE	VCR BRAND NAME	BRAND CODE
GE	1 1	NEC	3 7	RCA	9 2
	9 2		3 8		9 4
	9 0	PHILIPS	1 9		6 6
	9 4		9 5		6 3
HITACHI	6 6	PANASONIC	1 1	SANYO	3 6
	6 3		9 4		3 5
	JVC A		9 1	9 1	SHARP
9 6			9 6	1 0	
B			9 3	1 2	SONY
C	9 3		3 3	6 0	
MAGNAVOX	9 5		7 2	TOSHIBA	
	1 1		1 3		3 1
	7 1		1 7		ZENITH
7 6	1 1		6 1		
MITSUBISHI	6 7	9 4	1 8	1 6	
	6 8				

Refer to the diagrams on page 52 and 54 for the controls, indications, indicators and connectors mentioned.

- Make sure to set "S/AV INPUT" to "OFF" in the Menu Screen (☞ pg. 35).
- When editing on a VCR equipped with a DV input connector, an optional DV cable can be connected instead of an S-Video cable and audio/video cable.

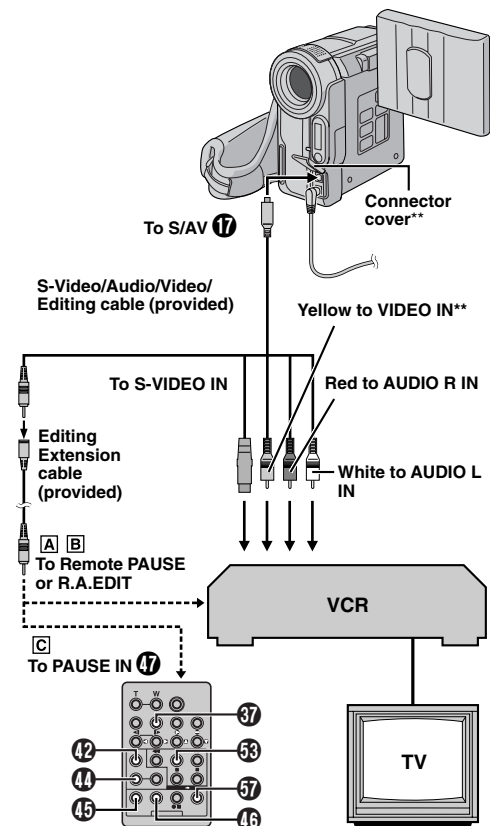

\* Connect when the S-Video connection is not used.

\*\* When connecting cables, open this cover.

## SELECT SCENES

**4** Point the remote control at the camcorder's remote sensor. Press **PLAY** (▶) **38** and then press **R.A.EDIT ON/OFF** **57** on the remote control. The Random Assemble Editing Menu appears.

**5** If using a Fade/Wipe at the beginning of the scene, press **FADE/WIPE** **12** on the remote control (☞ pg. 28, 43).

• Cycle through the effects by pressing repeatedly, and stop when the one you want is displayed.

**6** At the beginning of the scene, press **EDIT IN/OUT** **45** on the remote control. The Edit-In position appears in the Random Assemble Editing Menu.

**7** At the end of the scene, press **EDIT IN/OUT** **45**. The Edit-Out position appears in the Random Assemble Editing Menu.

**8** If using a Fade/Wipe at the end of the scene, press **FADE/WIPE** **12** (☞ pg. 28, 43).

• Cycle through the effects by pressing repeatedly, and stop when the one you want is displayed.

• If you select a Fade/Wipe effect for an Edit-Out point, the effect is automatically applied to the following Edit-In point.

• When you use Fade/Wipe effects, that time is included in the total time.

**9** If using Playback Special Effects, press **EFFECT** **44** (☞ pg. 39).

**10** Repeat steps **6** through **9** to register additional scenes.

• To change previously registered points, press **CANCEL** **46** on the remote control. The registered points disappear, one at a time, from the most recently registered point.

• If you are not using Fade/Wipe or Program AE with special effects, repeat steps **6** and **7** only.

## NOTES:

- When choosing a scene, set Edit-In and Edit-Out points so that there is a relatively large difference between them.
- If the search time for an in-point exceeds 5 minutes, the recording deck's Record-Standby mode will be cancelled and editing will not take place.
- If there are blank portions before or after the Edit-In and Edit-Out points, a blue screen may be included in the edited version.
- Since time codes register time only as accurately as seconds, the time code total time may not match the total program time exactly.
- Turning off the camcorder's power erases all registered Edit-In and Edit-Out points.
- If you select Sepia or Monotone mode from Program AE with special effects, you cannot use the Black & White Fader. In this case the Black & White indicator begins blinking. Once the next Edit-In point is registered, the effect is turned off. To combine these effects, use Sepia or Monotone during recording, then use the Black & White Fader during Random Assemble Editing.
- It is not possible to use Fade/Wipe effects and Program AE with special effects during Random Assemble Editing using a DV cable.

Refer to the diagrams on page 52 and 54 for the controls, indications, indicators and connectors mentioned.

## Picture Wipe/Dissolve (GR-DX300 only)

(available only for Random Assemble Editing)

You can also use the fade/wipe effects on page 28.

### DISSOLVE

The new scene gradually appears as the old one gradually disappears.

### WIPE — CORNER

The new scene wipes in over the previous one from the upper right corner to the lower left corner.

### WIPE — WINDOW

The next scene gradually wipes in from the center of the screen toward the corners, covering the previous scene.

### WIPE — SLIDE

The next scene gradually wipes in over the previous one from right to left.

### WIPE — DOOR

The previous scene wipes out from the center to the right and left, like a door being pushed open to reveal the next scene.

### WIPE — SCROLL

The new scene wipes in over the last one from the bottom of the screen to the top.

### WIPE — SHUTTER

The new scene wipes in over the previous one from the center toward the top and bottom of the screen.

## AUTOMATIC EDITING TO VCR

**11** Rewind the tape in the camcorder to the beginning of the scene you want to edit and press **PAUSE (II) 66**.

**12** Point the remote control towards the VCR's remote sensor and press **VCR REC STBY (●II) 68**, or manually engage the VCR's Record-Pause mode.

**13** Press **START/STOP 49** on the remote control. Editing proceeds as programmed, right through to the end of the last registered scene.

- When dubbing is complete, the camcorder enters the Pause mode, and the VCR enters its Record-Pause mode.
- If you do not register an Edit-Out point, the tape will be dubbed all the way to the end automatically.
- If you operate the camcorder during automatic editing, the VCR will enter its Record-Pause mode and automatic editing will stop.

**14** Engage the Stop modes for the camcorder and the VCR.

To make the R.A.Edit counter display disappear, press **R.A.EDIT ON/OFF 77** on the remote control.

### NOTES:

- Pressing **R.A.EDIT ON/OFF 77** on the remote control clears all settings registered during Random Assemble Editing.
- When the editing cable is connected to the remote control's Pause In connector during dubbing, make sure the remote control is pointed at the VCR's sensor, and the path between the two is unobstructed.
- Random Assemble Editing may not function properly when using a tape including several duplicated time codes (see pg. 14).

## For More Accurate Editing

Some VCRs make the transition from Record-Pause to Record mode faster than others. Even if you begin editing for the camcorder and the VCR at exactly the same time, you may lose scenes you wanted, or find that you have recorded scenes you did not want. For a cleanly edited tape, confirm and adjust the timing of the camcorder against your VCR.

## DIAGNOSING VCR/CAMCORDER TIMING

**1** Play back the tape in the camcorder, then point the remote control at the camcorder's remote sensor and press **R.A.EDIT ON/OFF 77**.

The Random Assemble Editing Menu appears.

**2** Perform Random Assemble Editing on Program 1 only. In order to check VCR and camcorder timing, select the beginning of a scene transition as your Edit-In point.

**3** Play back the dubbed scene.

- If any images from the scene prior to the transition you chose for your Edit-In point were recorded, that means your VCR moves too quickly from Record-Pause to Record mode.
- If the scene you tried to dub starts in progress, the VCR is slow to start recording.

## ADJUSTMENT OF VCR/CAMCORDER TIMING

**4** Point the remote control at the camcorder's remote sensor and press **R.A.EDIT ON/OFF 77** to make the Random Assemble Editing menu disappear, then press **MENU 1**. The Menu Screen appears.

**5** Press + or - **5** to select "**VIDEO**" and press **SELECT/SET 3**. Then, press + or - **5** to select "SYNCHRO" and press **SELECT/SET 3**. The value for "SYNCHRO" is highlighted.

**6** Based on the diagnostics performed, you can now advance the VCR's record timing by pressing + **5**. You can also delay the VCR's record timing by pressing - **5**. The adjustment range is from -1.3 to +1.3 seconds, in 0.1-second increments. Press **SELECT/SET 3** to finish the setting.

**7** Press + or - **5** to select "**RETURN**" and press **SELECT/SET 3** twice.

Now perform Random Assemble Editing beginning with step 4 on page 42.

### NOTES:

- Before performing actual Random Assemble Editing, do a few Random Assemble Editing trial runs to check whether the value you have input is appropriate or not, and make adjustments accordingly.
- Depending on the recorder, there may be situations where the timing difference cannot be fully corrected.

Refer to the diagrams on page 52 and 54 for the controls, indications, indicators and connectors mentioned.

#### [A] Using USB cable

It is possible to do the following things:

- Transfer still/moving images stored on a memory card to a PC.
- Transfer still/moving images recorded on a tape to a PC.
- Capture still/moving images in real-time.
- Use this camcorder as a WebCam.

#### [B] Using DV cable

It is also possible to transfer still/moving images to a PC with a DV connector by using the provided software, software equipped with the PC or commercially available software.

#### NOTES:

- Refer to "SOFTWARE INSTALLATION AND USB CONNECTION GUIDE" for the installation of the bundled software and drivers.
- It is recommended to use the AC Adapter as the power supply instead of the battery pack (pg. 7).
- Never connect the USB cable and the DV cable simultaneously to the camcorder. Connect only the cable you wish to use to the camcorder.
- If the PC connected to the camcorder via the USB cable is not powered, the camcorder does not enter the USB mode.
- The date/time information cannot be captured into the PC.
- Use the provided software PIXELA ImageMixer to capture video in real-time.
- You can also use the camcorder for webconference by using Windows® Microsoft Netmeeting and signing up for Microsoft Hotmail.
- Refer to the instruction manuals of the PC and Software.
- The still images can also be transferred to a PC with a DV connector-equipped capture board.
- When using a DV cable, be sure to use the optional JVC VC-VDV206U or VC-VDV204U DV cable depending on the type of DV connector (4 or 6 pins) on the PC.
- The system may not work properly depending on the PC or capture board you are using.
- When using the DV connection refer to manufacturer instructions of your capture board for driver's installation and operation instructions.

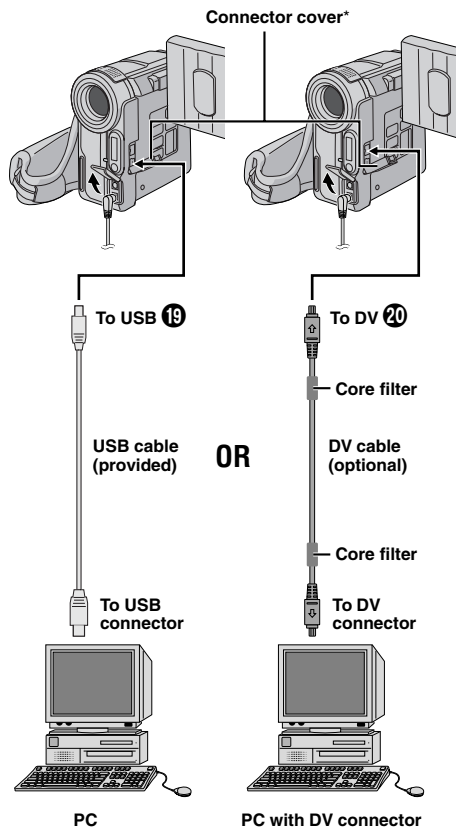

\* When connecting cables, open this cover.

"ACCESSING FILES" appears on the LCD monitor while the PC is accessing data in the camcorder or the camcorder is transferring a file to the PC.

**NEVER disconnect the USB cable while "ACCESSING FILES" is displayed on the LCD monitor since this can result in product damage.**

Refer to the diagrams on page 52 and 54 for the controls, indications, indicators and connectors mentioned.

Before consulting your JVC dealer, please check the following to see if you can correct the problem yourself.

The camcorder is a microcomputer-controlled device. External noise and interference (from a TV, a radio, etc.) might prevent it from functioning properly. In such cases, first disconnect its power supply unit (battery pack, AC Adapter, etc.) and wait a few minutes; and then re-connect it and proceed as usual from the beginning.

### No power is supplied.

- The power is not connected properly.  
→ Connect the AC Adapter securely (☞ pg. 7).
- The battery is dead.  
→ Replace the dead battery with a fully charged one (☞ pg. 7, 8).

### “SET DATE/TIME!” appears.

- The date/time is not set.  
→ Set the date/time (☞ pg. 10).
- The built-in clock's rechargeable lithium battery is discharged.
- The previously set date/time is erased.  
→ Connect the camcorder to an AC outlet using the AC Adapter for over 24 hours to charge the clock's lithium battery (☞ pg. 49).

### Recording cannot be performed.

- For Tape Recording ——
- The tape's erase protection tab is set to “SAVE”.  
→ Set the tape's erase protection tab to “REC” (☞ pg. 9).
  - The Power Switch **12** is set to “PLAY” or “OFF”.  
→ Set the Power Switch **12** to “**A**” or “**M**” (☞ pg. 13).
  - The VIDEO/MEMORY Switch **25** is set to “MEMORY”.  
→ Set the VIDEO/MEMORY Switch **25** to “VIDEO”.
  - “TAPE END” appears.  
→ Replace with new cassette (☞ pg. 9).
  - The cassette holder cover is open.  
→ Close the cassette holder cover.

- For Memory Card Recording ——
- The VIDEO/MEMORY Switch **25** is set to “VIDEO”.  
→ Set the VIDEO/MEMORY Switch **25** to “MEMORY”.

### There is no picture.

- The camcorder is not getting power, or some other malfunction exists.  
→ Turn the camcorder's power off and on again (☞ pg. 13).

### The flash does not work when shooting a still image.

- The flash sensor is blocked by a finger.  
→ When holding the camcorder, make sure not to block the flash sensor with your fingers.

### The focus does not adjust automatically.

- Focus is set to the Manual mode.  
→ Set Focus to the Auto mode (☞ pg. 30).
- The recording was done in a dark place, or the contrast was low.
- The lens is dirty or covered with condensation.  
→ Clean the lens and check the focus again (☞ pg. 50).

### The cassette will not load properly.

- The cassette is in the wrong position.  
→ Set it in the right position (☞ pg. 9).
- The battery's charge is low.  
→ Install a fully charged battery (☞ pg. 7, 8).

### The memory card will not load properly.

- The memory card is in the wrong position.  
→ Set it in the right position (☞ pg. 11).

### In the 5-Second mode, recording ends before 5 seconds have elapsed.

- The 5-Second mode is set to “Anim.” in the Menu Screen.  
→ Select “5S” in the Menu Screen (☞ pg. 26).

### Snapshot mode cannot be used.

- The Squeeze mode is selected.  
→ Disengage the Squeeze mode (☞ pg. 33).

### The color of Snapshot looks strange.

- The light source or the subject does not include white. Or there are various different light sources behind the subject.  
→ Find a white subject and compose your shot so that it also appears in the frame (☞ pg. 17, 29).
- The Sepia or Monotone mode is activated.  
→ Turn off Sepia and Monotone (☞ pg. 27).

### The image taken using Snapshot is too dark.

- Shooting was performed under backlight conditions.  
→ Press the BACKLIGHT Button **22** (☞ pg. 30).

### The image taken using Snapshot is too bright.

- The subject is too bright.  
→ Set “PROGRAM AE” to “SPOTLIGHT” in the Menu Screen (☞ pg. 27).

### Digital Zoom does not work.

- 10X\*/16X\*\* optical zoom is selected.  
→ Set “ZOOM” to “40X” or “500X\*/700X\*\*” in the Menu Screen (☞ pg. 32).
- The VIDEO/MEMORY Switch **25** is set to “MEMORY”.  
→ Set the VIDEO/MEMORY Switch **25** to “VIDEO” (☞ pg. 13).

\* GR-DX300 only.

\*\* GR-DX95/DX75 only.

**Refer to the diagrams on page 52 and 54 for the controls, indications, indicators and connectors mentioned.**

### **The Black & White Fader does not work.**

- The Sepia or Monotone mode is activated.
- Turn off Sepia and Monotone (☞ pg. 27).

### **During R.A.Edit, the Dissolve function does not work.**

- The Sepia or Monotone mode of Program AE with special effects is activated.
- Turn off Sepia or Monotone before adding Dissolve to a scene transition (☞ pg. 27, 43).
- The previously selected mode of Program AE with special effects was changed after the last selected scene for editing was registered.
- Make sure you have selected the mode of Program AE with special effects you want before starting editing (☞ pg. 27, 43).

### **During R.A.Edit, the Picture Wipe and Dissolve functions do not work.**

- The last selected editing scene is ending.
- Select Picture Wipe or Dissolve before beginning editing. The effects are then automatically activated (☞ pg. 42, 43).
- At the end of the last selected scene for editing, the Power Switch **Ⓜ** was set to "OFF".
- Do not turn off the camcorder's power after setting Edit-In and Edit-Out points, as they will all be erased (☞ pg. 42).
- The power is off.
- The camcorder automatically shuts off after 5 minutes have elapsed in the Pause mode. Make sure you continue operations within 5 minutes after engaging Pause mode (☞ pg. 42, 43).

### **Scene transition does not go as expected.**

- When using "Picture Wipe/Dissolve" (☞ pg. 43), there is a delay of a fraction of a second between the previous record stop-point and the Dissolve start-point. This is normal, but this slight delay becomes especially noticeable when shooting fast-moving subject or during rapid panning.

### **The image looks like the shutter speed is too slow.**

- When shooting in the dark, the unit becomes highly sensitive to light when "GAIN UP" is set to "AUTO" in the Menu Screen.
- If you want the lighting to look more natural, set "GAIN UP" to "AGC" or "OFF" in the Menu Screen (☞ pg. 33).

### **White Balance cannot be activated.**

- The Sepia or Monotone mode is activated.
- Turn off Sepia or Monotone before setting White Balance (☞ pg. 27, 31).

### **When shooting a subject illuminated by bright light, vertical lines appear.**

- This is a result of exceedingly high contrast, and is not a malfunction.

### **When the screen is under direct sunlight during shooting, the screen becomes red or black for an instant.**

- This is not a malfunction.

### **The date/time does not appear.**

- "DATE/TIME" is set to "OFF" in the Menu Screen.
- Set "DATE/TIME" to "ON" in the Menu Screen (☞ pg. 34, 36).

### **Files stored on the memory card cannot be deleted.**

- Files stored on the memory card are protected.
- Remove protection from the files stored on the memory card and delete them (☞ pg. 20).

### **Time code does not appear.**

- "TIME CODE" is set to "OFF" in the Menu Screen.
- Set "TIME CODE" to "ON" in the Menu Screen (☞ pg. 35, 36).

### **Images on the LCD monitor appear dark or whitish.**

- In places subject to low temperature, images become dark due to the characteristics of the LCD monitor. When this happens, the displayed colors differ from those that are actually recorded. This is not a defect of the camcorder.
- When the LCD monitor's fluorescent light reaches the end of its service life, images on the LCD monitor become dark. Consult your nearest JVC dealer.
- Adjust the brightness and angle of the LCD monitor (☞ pg. 12).

### **The rear of the LCD monitor is hot.**

- The light used to illuminate the LCD monitor causes it to become hot.
- Close the LCD monitor to turn it off or set the Power Switch **Ⓜ** to "OFF", and let the unit cool down.

### **The indicators and the image color on the LCD monitor are not clear.**

- This may occur when the surface or the edge of the LCD monitor is pressed.

### **The LCD monitor or viewfinder indications blink.**

- Certain Fade/Wipe effects, certain modes of Program AE with special effects, "DIS" and other functions that cannot be used together are selected at the same time.
- Re-read the sections covering Fade/Wipe effects, Program AE with special effects and "DIS" (☞ pg. 27, 28, 33).

### **Refer to the diagrams on page 52 and 54 for the controls, indications, indicators and connectors mentioned.**

### Coloured bright spots appear all over the LCD monitor or the viewfinder.

- The LCD monitor and the viewfinder are made with high-precision technology. However, black spots or bright spots of light (red, green or blue) may appear constantly on the LCD monitor or the viewfinder. These spots are not recorded on the tape. This is not due to any defect of the unit. (Effective dots: more than 99.99 %)

### During recording, sound cannot be heard.

- This is normal.

### Play, Rewind and Fast-Forward functions do not work.

- The Power Switch **Ⓜ** is set to “**A**” or “**M**”.  
→ Set the Power Switch **Ⓜ** to “**PLAY**” (☞ pg. 14).

### A memory card cannot be played back.

- The Power Switch **Ⓜ** is set to “**A**” or “**M**”.  
→ Set the Power Switch **Ⓜ** to “**PLAY**” (☞ pg. 18).
- The **VIDEO/MEMORY** Switch **Ⓜ** is set to “**VIDEO**”.  
→ Set the **VIDEO/MEMORY** Switch **Ⓜ** to “**MEMORY**”.

### The LCD monitor image is distorted.

- During playback of the unrecorded portion, High-speed Search and still playback, LCD monitor indications appear distorted. This is not a defect.

### Images on the LCD monitor are jittery.

- The speaker volume is too great.  
→ Turn the speaker volume down (☞ pg. 14).

### There is no playback picture on the connected TV.

- Since the analog input mode is engaged, the camcorder is in the Record-Standby mode.  
→ Set “S/AV INPUT” to “OFF” in the Menu Screen (☞ pg. 35).

### Blocks of noise appear during playback, or there is no playback picture and the screen becomes blue.

- Clean the video heads with an optional cleaning cassette (☞ pg. 49).

### The LCD monitor, the viewfinder and the lens have become dirty (ex. fingerprints).

- Wipe them gently with soft cloth. Wiping strongly can cause damage (☞ pg. 50).

### An unusual mark appears.

- Check the section of the manual that explains LCD monitor/viewfinder indications (☞ pg. 54 – 57).

### An error indication (E01, E02 or E06) appears.

- A malfunction of some kind has occurred. In this case the camcorder's functions become unusable.  
→ Remove the power supply (battery pack, etc.) and wait a few minutes for the indication to clear. When it does, you can resume using the camcorder. If the indication remains even though you repeat the above two or three times, please consult your nearest JVC dealer. Do not eject the cassette. This will cause damage to the tape.

### An error indication (E03 or E04) appears.

- A malfunction of some kind has occurred. In this case the camcorder's functions become unusable.  
→ Eject the cassette once and re-insert it, then check if the indication clears. When it does, you can resume using the camcorder. If the indication remains even though you repeat the above two or three times, please consult your nearest JVC dealer.

### The charger indicator on the camcorder does not light.

- The temperature of the battery is extremely high/low.
- Charging is difficult in places subject to extremely high/low temperatures.  
→ To protect the battery, it is recommended to charge it in places with a temperature of 10°C to 35°C (50°F to 95°F) (☞ pg. 48).

### When the image is printed from the printer, a black bar appears at the bottom of the screen.

- This is not a malfunction.  
→ By recording with “DIS” activated (☞ pg. 33) this can be avoided.

### When the camcorder is connected via the DV connector, the camcorder does not operate.

- The DV cable was plugged/unplugged with power turned on.  
→ Turn the camcorder's power off and on again, then operate it.

### The memory card cannot be removed from the camcorder.

- Push in the memory card a few more times (☞ pg. 11).

Refer to the diagrams on page 52 and 54 for the controls, indications, indicators and connectors mentioned.

## AC Adapter

### When using the AC Adapter in areas other than the USA

- The provided AC Adapter features automatic voltage selection in the AC range from 110 V to 240 V.

### USING HOUSEHOLD AC PLUG ADAPTER

In case of connecting the unit's power cord to an AC wall outlet other than American National Standard C73 series type use an AC plug adapter, called a "Siemens Plug", as shown.

For this AC plug adapter, consult your nearest JVC dealer.

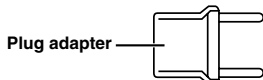

- If there is dust or dirt on the AC Adapter, wipe it clean before using.

## General Battery Precautions

If the remote control is not functioning even if it is being operated correctly, the batteries are exhausted. Replace them with fresh ones.

**Use only the following batteries:** AAA (R03) size x 2  
Please make note of the following rules for battery use. When misused, the batteries can leak or explode.

1. When replacing batteries, refer to page 5.
2. **Do not** use any different size of batteries from those specified.
3. Be sure to install batteries in the correct direction.
4. **Do not** use rechargeable batteries.
5. **Do not** expose the batteries to excessive heat as they can leak or explode.
6. **Do not** dispose of the batteries in a fire.
7. Remove the batteries from the unit if it is to be stored for an extended period to avoid battery leakage which can cause malfunctions.
8. **Do not** recharge the provided batteries.

## Battery Packs

The supplied battery pack is a lithium-ion battery. Before using the supplied battery pack or an optional battery pack, be sure to read the following cautions:

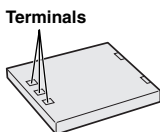

1. **To avoid hazards . . .**
  - ... **do not** burn.
  - ... **do not** short-circuit the terminals. When transporting, make sure the provided battery cap is attached to the battery. If the battery cap is misplaced, carry the battery in a plastic bag.
  - ... **do not** modify or disassemble.
  - ... **do not** expose the battery to temperatures exceeding 60°C (140°F), as this may cause the battery to overheat, explode or catch fire.
  - ... use only specified chargers.
2. **To prevent damage and prolong service life . . .**
  - ... **do not** subject to unnecessary shock.
  - ... charge in an environment where temperatures are within the tolerances shown in the following chart. This is a chemical reaction type battery—cooler temperatures impede chemical reaction, while warmer temperatures can prevent complete charging.

- ... store in a cool, dry place. Extended exposure to high temperatures will increase natural discharge and shorten service life.
- ... fully charge and then fully discharge the battery every 6 months when storing the battery pack over a long period time.
- ... remove from charger or powered unit when not in use, as some machines use current even when switched off.

## NOTES:

- It is normal for the battery pack to be warm after charging, or after use.
- ### Temperature Range Specifications
- |           |       |                              |
|-----------|-------|------------------------------|
| Charging  | ..... | 10°C to 35°C (50°F to 95°F)  |
| Operation | ..... | 0°C to 40°C (32°F to 104°F)  |
| Storage   | ..... | -10°C to 30°C (14°F to 86°F) |
- Recharging time is based on room temperature of 20°C (68°F).
  - The lower the temperature, the longer recharging takes.

## Cassettes

To properly use and store your cassettes, be sure to read the following cautions:

### 1. During use . . .

- ... make sure the cassette bears the Mini DV mark.
- ... be aware that recording onto prerecorded tapes automatically erases the previously recorded video and audio signals.
- ... make sure the cassette is positioned properly when inserting.
- ... do not load and unload the cassette repeatedly without allowing the tape to run at all. This slackens the tape and can result in damage.
- ... do not open the front tape cover. This exposes the tape to fingerprints and dust.

### 2. Store cassettes . . .

- ... away from heaters or other heat sources.
- ... out of direct sunlight.
- ... where they won't be subject to unnecessary shock or vibration.
- ... where they won't be exposed to strong magnetic fields (such as those generated by motors, transformers or magnets).
- ... vertically, in their original cases.

## Memory Cards

To properly use and store your memory cards, be sure to read the following cautions:

### 1. During use . . .

- ... make sure the memory card bears the SD or MultiMediaCard mark.
- ... make sure the memory card is positioned properly when inserting.

### 2. While the memory card is being accessed (during recording, playback, deletion, initialization, etc.) . . .

- ... never unload the memory card and never turn off the camcorder.

### 3. Store memory cards . . .

- ... away from heaters or other heat sources.
- ... out of direct sunlight.
- ... where they won't be subject to unnecessary shock or vibration.
- ... where they won't be exposed to strong magnetic fields (such as those generated by motors, transformers or magnets).



## LCD Monitor

### 1. To prevent damage to the LCD monitor, DO NOT . . .

- ... push it strongly or apply any shocks.
- ... place the camcorder with the LCD monitor on the bottom.

### 2. To prolong service life . . .

- ... avoid rubbing it with coarse cloth.

### 3. Be aware of the following phenomena for LCD monitor use.

#### These are not malfunctions:

- While using the camcorder, the surface around the LCD monitor and/or the back of the LCD monitor may heat up.
- If you leave power on for a long time, the surface around the LCD monitor becomes hot.

## Main Unit

### 1. For safety, DO NOT . . .

- ... open the camcorder's chassis.
- ... disassemble or modify the unit.
- ... short-circuit the terminals of the battery pack. Keep it away from metallic objects when not in use.
- ... allow inflammables, water or metallic objects to enter the unit.
- ... remove the battery pack or disconnect the power supply while the power is on.
- ... leave the battery pack attached when the camcorder is not in use.

### 2. Avoid using the unit . . .

- ... in places subject to excessive humidity or dust.
- ... in places subject to soot or steam such as near a cooking stove.
- ... in places subject to excessive shock or vibration.
- ... near a television set.
- ... near appliances generating strong magnetic or electric fields (speakers, broadcasting antennas, etc.).
- ... in places subject to extremely high (over 40°C/104°F) or extremely low (under 0°C/32°F) temperatures.

### 3. DO NOT leave the unit . . .

- ... in places of over 50°C (122°F).
- ... in places where humidity is extremely low (below 35%) or extremely high (above 80%).
- ... in direct sunlight.
- ... in a closed car in summer.
- ... near a heater.

### 4. To protect the unit, DO NOT . . .

- ... allow it to become wet.
- ... drop the unit or strike it against hard objects.
- ... subject it to shock or excessive vibration during transportation.
- ... keep the lens directed at extremely bright objects for long periods.
- ... expose the lens to direct sunlight.
- ... carry it by holding the LCD monitor or the viewfinder.
- ... swing it excessively when using the strap or the grip.

### 5. Dirty heads can cause the following problems:

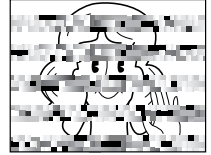

- No picture during playback.
- Blocks of noise appear during playback.
- During recording or playback, the Head Clog Warning indicator "⊗" appears.
- Recording cannot be performed properly.

In such cases, use an optional cleaning cassette. Insert it and play back. If the cassette is used more than once consecutively, damage to the video heads may result. After the camcorder plays back for about 20 seconds, it stops automatically. Also refer to the cleaning cassette's instructions.

If, after using the cleaning cassette, the problems still exist, consult your nearest JVC dealer.

Mechanical moving parts used to move the video heads and video tape tend to become dirty and worn out over time. In order to maintain a clear picture at all times, periodic check-ups are recommended after using the unit for about 1,000 hours. For periodic check-ups please consult your nearest JVC dealer.

## Built-in Clock's Rechargeable Lithium Battery

To store the date/time in memory, the clock's rechargeable lithium battery is integrated in the camcorder. While the camcorder is connected to an AC outlet using the AC Adapter, or while the battery pack attached to the camcorder continues to supply power, the clock's rechargeable lithium battery is always charged. However, if the camcorder is not used for approx. 3 months, the clock's lithium battery will become discharged and the date/time stored in memory will be lost. When this occurs, first connect the camcorder to an AC outlet using the AC Adapter for over 24 hours to charge the clock's rechargeable lithium battery. Then perform the date/time setting before using the camcorder.

Note that the camcorder can be used without setting the date/time.

## How to handle a CD-ROM

- Take care not to soil or scratch the mirror surface (opposite to the printed surface). Do not write anything or put a sticker on either the front or back surface. If the CD-ROM gets dirty, gently wipe it with a soft cloth outward from the center hole using a circular motion.
- Do not use conventional disc cleaners or cleaning spray.
- Do not bend the CD-ROM or touch its mirror surface.
- Do not store your CD-ROM in a dusty, hot or humid environment. Keep it away from direct sunlight.

### About moisture condensation . . .

- You have observed that pouring a cold liquid into a glass will cause drops of water to form on the glass outer surface. This same phenomenon occurs on the head drum of a camcorder when it is moved from a cool place to a warm place, after heating a cold room, under extremely humid conditions or in a place directly subjected to the cool air from an air conditioner.
- Moisture on the head drum can cause severe damage to the video tape, and can lead to internal damage to the camcorder itself.

### Serious malfunctioning

If malfunctioning occurs, stop using the unit immediately and consult your local JVC dealer.

The camcorder is a microcomputer-controlled device. External noise and interference (from a TV, a radio, etc.) might prevent it from functioning properly. In such cases, first disconnect its power supply unit (battery pack, AC Adapter, etc.) and wait a few minutes and then reconnect it and proceed as usual from the beginning.

### Declaration of Conformity

**Model Number** : GR-DX300US/DX95US/  
DX75US  
**Trade Name** : JVC  
**Responsible party** : JVC AMERICAS CORP.  
**Address** : 1700 Valley Road Wayne,  
N. J. 07470  
**Telephone Number** : 973-317-5000

This device complies with Part 15 of FCC Rules. Operation is subject to the following two conditions:  
(1) This device may not cause harmful interference, and  
(2) this device must accept any interference received, including interference that may cause undesired operation.

Change or modifications not approved by the party responsible for compliance could void the user's authority to operate the equipment. This equipment has been tested and found to comply with the limits for a Class B digital device, pursuant to Part 15 of the FCC Rules. These limits are designed to provide reasonable protection against harmful interference in a residential installation. This equipment generates, uses, and can radiate radio frequency energy and, if not installed and used in accordance with the instructions, may cause harmful interference to radio communications. However, there is no guarantee that interference will not occur in a particular installation. If this equipment does cause harmful interference to radio or television reception, which can be determined by turning the equipment off and on, the user is encouraged to try to correct the interference by one or more of the following measures:



- Reorient or relocate the receiving antenna.
- Increase the separation between the equipment and receiver.
- Connect the equipment into an outlet on a circuit different from that to which the receiver is connected.
- Consult the dealer or an experienced radio/TV technician for help.

This Class B digital apparatus complies with Canadian ICES-003.

Cet appareil numérique de la classe B est conforme à la norme NMB-003 du Canada.

## For Your Maintenance

### 1) After Use

1. Turn off the camcorder.
2. Slide and hold **OPEN/EJECT**  in the direction of the arrow, then pull the cassette holder cover open until it locks. The cassette holder opens automatically. Remove the cassette.
3. Press "PUSH HERE" to close the cassette holder.
  - Once the cassette holder is closed, it recedes automatically. Wait until it recedes completely before closing the cassette holder cover.
4. Tilt the viewfinder upward. Press **BATT. RELEASE**  and remove the battery pack.

### 2) Cleaning The Camcorder

1. To clean the exterior, wipe gently with a soft cloth. Put the cloth in diluted mild soap and wring it well to wipe off heavy dirt. Then wipe again with a dry cloth.
2. Open the LCD monitor. Wipe gently with a soft cloth. Be careful not to damage the monitor. Close the LCD monitor.
3. To clean the lens, blow it with a blower brush, then wipe gently with lens cleaning paper.
4. To clean the viewfinder, pull out the viewfinder and open it.
5. Insert a lens blower or soft cloth and clean the interior of the viewfinder with it.
6. Close the viewfinder and push it back in.

### NOTES:

- Avoid using strong cleaning agents such as benzine or alcohol.
- Cleaning should be done only after the battery pack has been removed or other power units have been disconnected.
- Mould may form if the lens is left dirty.
- When using a cleaner or chemically treated cloth refer to the cautions of each product.

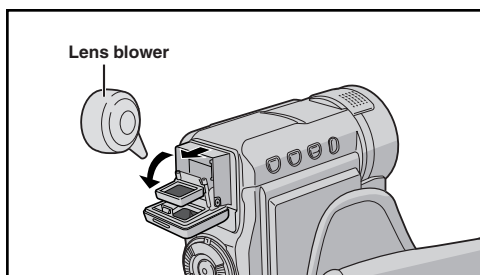

## Camcorder

### General

**Power supply** : DC 11.0 V  (Using AC Adapter)  
DC 7.2 V  (Using battery pack)

### Power consumption

**LCD monitor off,  
viewfinder on** : Approx. 3.4 W

**LCD monitor on,  
viewfinder off** : Approx. 4.6 W

### Dimensions

**(W x H x D)** : 55 mm x 102 mm x 96 mm (2-1/4"  
x 4-1/16" x 3-13/16")  
(with the LCD monitor closed and  
the viewfinder pushed back in)

**Weight** : Approx. 440 g (0.97lbs) (without  
grip belt) (GR-DX300)  
Approx. 450 g (1lbs) (without grip  
belt) (GR-DX95/DX75)

### Operating

**temperature** : 0°C to 40°C (32°F to 104°F)

### Operating

**humidity** : 35% to 80%

### Storage

**temperature** : -20°C to 50°C (-4°F to 122°F)

### Pickup

: 1/4" CCD (GR-DX300)

1/6" CCD (GR-DX95/DX75)

### Lens

: F 1.8, f = 3.8 mm to 38 mm (0.15"  
to 1.5"),  
10:1 power zoom lens  
(GR-DX300)

F1.6, f = 2.7 mm to 43.2 mm (0.11"  
to 1.7"),  
16:1 power zoom lens  
(GR-DX95/DX75)

### Filter diameter

:  $\varnothing$ 30.5 mm (1.2")

### LCD monitor

: 3" diagonally measured, LCD  
panel/TFT active matrix system  
(GR-DX300/DX95)

2.5" diagonally measured, LCD  
panel/TFT active matrix system  
(GR-DX75)

### Viewfinder

: Electronic viewfinder with 0.24"

black/white LCD

### Speaker

: Monaural

## Digital Video Camera

**Format** : DV format (SD mode)

**Signal format** : NTSC standard

### Recording/

**Playback format** : Video: Digital component recording

: Audio: PCM digital recording,

32 kHz 4-channel (12-bit),

48 kHz 2-channel (16-bit)

### Cassette

: Mini DV cassette

### Tape speed

: SP : 18.8 mm/s

LP : 12.5 mm/s

### Maximum

**recording time** : SP : 80 min.

(using 80 min.  
cassette) LP : 120 min.

## Digital Still Camera Function

**Storage media** : SD Memory Card/MultiMediaCard

### Compression system

: Still image : JPEG  
(compatible)

Moving image : MPEG4  
(compatible)

### File size

: 4 modes (1600 x 1200 pixels\*,  
1280 x 960 pixels\*,  
1024 x 768 pixels,

640 x 480 pixels)

### Picture quality

: 2 modes (FINE/STANDARD)

### Approximate number of

**storable images** :  pg. 18.

\* GR-DX300 only.

## Connectors

### S/AV

**S-Video output** : Y : 1 V (p-p), 75  $\Omega$ , analog

C : 0.29 V (p-p), 75  $\Omega$ , analog

### S-Video input

: Y : 0.8 V (p-p) - 1.2 V (p-p), 75  $\Omega$ ,  
analog

C : 0.2 V (p-p) - 0.4 V (p-p), 75  $\Omega$ ,  
analog

### Video output

: 1 V (p-p), 75  $\Omega$ , analog

### Video input

: 0.8 V (p-p) - 1.2 V (p-p), 75  $\Omega$ ,  
analog

### Audio output

: 300 mV (rms), 1 k $\Omega$ , analog,  
stereo

### Audio input

: 300 mV (rms), 50 k $\Omega$ , analog,  
stereo

### Edit

:  $\varnothing$ 3.5 mm (0.14"), 2-pole

### DV

#### Output

: 4-pin, IEEE 1394 compliant

#### Input

: 4-pin, IEEE 1394 compliant

### USB

: 5-pin

## AC Adapter

### Power requirement

**U.S.A and Canada** : AC 120 V $\sim$ , 60 Hz

**Other countries** : AC 110 V to 240 V $\sim$ , 50 Hz/60 Hz

### Output

: DC 11 V  , 1 A

*Specifications shown are for SP mode unless otherwise indicated. E & O.E. Design and specifications subject to change without notice.*

# Controls, Connectors And Indicators

Refer to this diagram while reading the instructions.

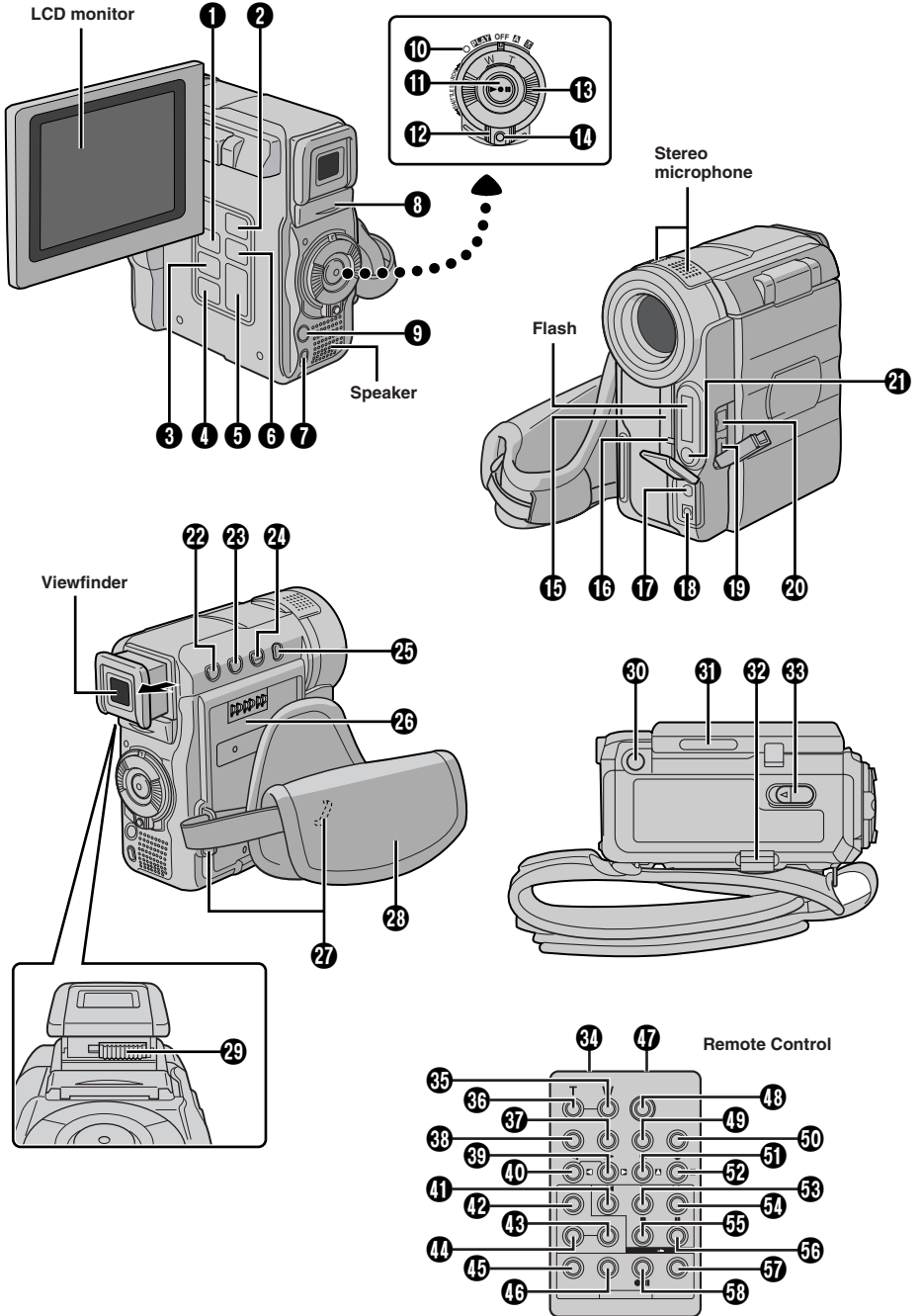

- 1 • INDEX Button ..... pg. 19
  - NAVI Button ..... pg. 21, 22
- 2 NAVI STORE Button ..... pg. 21, 22
- 3 SELECT/SET Button ..... pg. 32
- 4 MENU Button ..... pg. 32
- 5 • +, - Button ..... pg. 32
  - LCD Monitor Brightness Control [MONITOR BRIGHT +, -] ..... pg. 12
- 6 • E-MAIL Button ..... pg. 22
  - INFO Button ..... pg. 19
- 7 Stop Button [■] ..... pg. 14
- 8 MEMORY CARD Cover ..... pg. 11
- 9 Snapshot Button [SNAPSHOT] ..... pg. 17, 29
- 10 Power Lamp ..... pg. 7, 12, 13
- 11 • Recording Start/Stop Button ..... pg. 12
  - Play/Pause Button [▶/⏸] ..... pg. 14
- 12 Power Switch [A, M, PLAY, OFF] ..... pg. 13
- 13 • Power Zoom Ring [T/W] ..... pg. 13
  - SHUTTLE SEARCH Ring [◀◀/▶▶] ..... pg. 14
- 14 Lock Button ..... pg. 13
- 15 • Remote Sensor
  - The transmitted beam's approximate effective distance for indoor use is 5m.
  - The transmitted beam may not be effective or may cause incorrect operation outdoors or when the remote sensor is directly exposed to sunlight or powerful lighting.
  - Camera Sensor
    - Be careful not to cover this area, a sensor necessary for shooting is built-in here.
- 16 Tally Lamp ..... pg. 12, 34
- 17 • S-Video/Audio/Video Input/Output Connector [S/AV] ..... pg. 16, 37, 42
  - Edit Connector ..... pg. 42
- 18 DC Input Connector ..... pg. 7
- 19 USB (Universal Serial Bus) Connector ..... pg. 44
- 20 Digital Video Input/Output Connector [DV] (i.Link\*) ..... pg. 38, 44
  - \* i.Link refers to the IEEE1394-1995 industry specification and extensions thereof. The  logo is used for products compliant with the i.Link standard.
- 21 Flash Sensor
  - Be careful not to cover this area, as it contains a sensor required by the flash.
- 22 • BACKLIGHT Button ..... pg. 30
  - Speaker Volume Control [VOL. -] ..... pg. 14
- 23 • NIGHT Button ..... pg. 27
  - Speaker Volume Control [VOL. +] ..... pg. 14
- 24 • FOCUS Button ..... pg. 30
  - BLANK SEARCH Button ..... pg. 15
- 25 VIDEO/MEMORY Switch [VIDEO, MEMORY] ..... pg. 13
- 26 Battery Pack Mount ..... pg. 7
- 27 Grip Belt/Strap Eyelet
- 28 Grip Strap ..... pg. 8
- 29 Diopter Adjustment Control ..... pg. 8
- 30 Tripod Mounting Socket ..... pg. 9
- 31 Monitor Latch [OPEN] ..... pg. 12
- 32 Battery Release Button [BATT. RELEASE] ..... pg. 7
- 33 OPEN/EJECT Switch ..... pg. 9
- 34 Infrared Beam Transmitting Window
  - Transmits the beam signal
- 35 Zoom (W) Button ..... pg. 39
- 36 Zoom (T) Button ..... pg. 39
- 37 DISPLAY Button ..... pg. 16, 37, 41
- 38 SHIFT Button ..... pg. 39, 41
- 39 • SLOW Button [▶] ..... pg. 39
  - Right Button ..... pg. 39
- 40 • SLOW Button [◀] ..... pg. 39
  - Left Button ..... pg. 39
- 41 REW Button\*
- 42 FADE/WIPE Button ..... pg. 42
- 43 EFFECT ON/OFF Button ..... pg. 39
- 44 EFFECT Button ..... pg. 39
- 45 EDIT IN/OUT Button ..... pg. 42
- 46 CANCEL Button ..... pg. 42
- 47 PAUSE IN Connector ..... pg. 42
- 48 START/STOP Button\*
- 49 MBR SET Button ..... pg. 41
- 50 Snapshot Button\* [SNAPSHOT]
- 51 • Up Button ..... pg. 39
  - INSERT Button ..... pg. 40
- 52 • Down Button ..... pg. 39
  - A. DUB Button ..... pg. 40
- 53 PLAY Button\*
- 54 FF Button\*
- 55 STOP Button\*
- 56 PAUSE Button\*
- 57 R.A.EDIT ON/OFF Button ..... pg. 42, 43
- 58 VCR REC STBY Button ..... pg. 43

\* Functions the same as each corresponding button on the camcorder.

The connectors 17 – 20 are located beneath a cover.

During Tape Recording Only

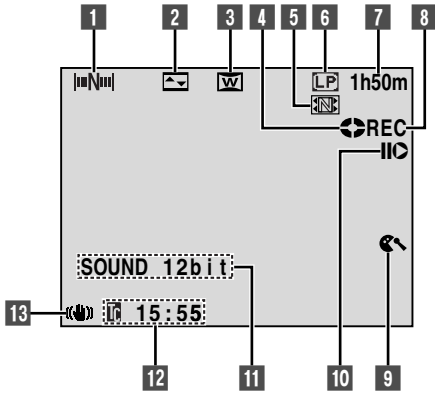

During Tape Playback

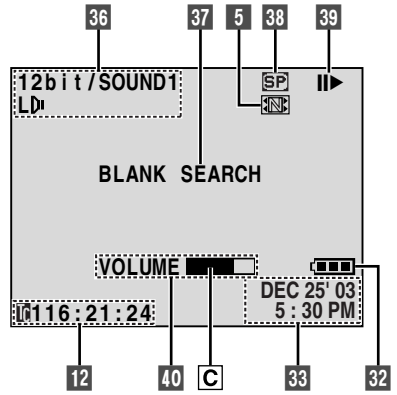

During Memory Card Recording Only

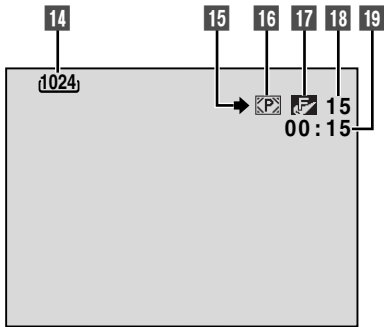

During Memory Card Playback

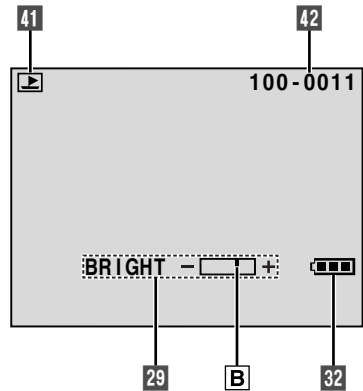

During Both Tape And Memory Card Recording

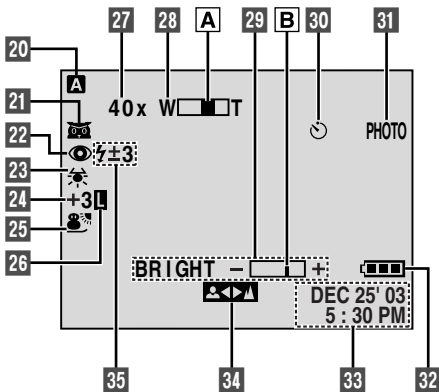

- Appears when "NAVIGATION" is set to other than "MANUAL" ..... pg. 21
- Displays the selected Fade/Wipe effect .... pg. 28
- Appears when in the Squeeze, Cinema or D.WIDE mode ..... pg. 33
- Rotates while the tape is running ..... pg. 12
- Appears while the captured image is being stored as a thumbnail image in the memory card ..... pg. 21
- Displays the recording mode (SP or LP) ... pg. 10
- Displays the tape remaining time ..... pg. 12
- • "REC" appears during recording
  - "PAUSE" appears during Record-Standby mode ..... pg. 12
- Appears when the wind cut mode is engaged to cut down on noise created by wind ..... pg. 33
- • Appears when the Insert Editing (C) or Insert Editing Pause (II C) mode is engaged .... pg. 40
- 5S/Anim.: Displays the 5 second recording mode or Animation recording mode (GR-DX300 only) ..... pg. 26, 33
- Displays the sound mode for approx. 5 seconds after turning on the camcorder ..... pg. 32
- Displays the Time Code ..... pg. 14, 35
- Appears when Digital Image Stabilizer ("DIS") is engaged ..... pg. 33
- Displays the image size ..... pg. 11
- Appears and blinks during shooting ..... pg. 17
- • : Appears during shooting ..... pg. 17
  - : Blinks when a memory card is not loaded ..... pg. 17
- Displays the picture quality
  - There are 2 modes available: F (Fine) and S (Standard) (in order of quality) ..... pg. 11
- • Displays the remaining number of shots that can be stored.
  - The number increases or decreases depending on the Picture Quality/Image Size, etc. .... pg. 17
  - Displays the remaining number of storable thumbnail images when it reaches 10 or less. .... pg. 21, 22
  - Displays the memory card remaining time for E-Mail Clip Recording ..... pg. 22
- Displays the E-Mail Clip Recording time ... pg. 22
- Appears when the Power Switch is set to "A" ..... pg. 13
- • : Appears when Night-Alive is engaged ..... pg. 27
- : Appears when "GAIN UP" is set to "AUTO" and the shutter speed is being automatically adjusted ..... pg. 33
- Appears when "FLASH" is set to "AUTO" in the Menu Screen ..... pg. 25
- Appears when the white balance is adjusted ..... pg. 31
- • "±" : Appears when the exposure is adjusted ..... pg. 30
- : Appears when backlight compensation is used ..... pg. 30
- Displays the selected Program AE with special effects ..... pg. 27
- Appears when the iris is locked ..... pg. 31
- Approximate zoom ratio: Appears during zooming ..... pg. 13
- Appears during zooming
  - Zoom level indicator ..... pg. 13
- Displays the brightness of the LCD monitor ..... pg. 12
  - The level indicator moves.
- Appears during Self-Timer recording (GR-DX300 only) ..... pg. 26
- Appears when taking a Snapshot ..... pg. 17, 29
- Displays the battery remaining power level ..... pg. 56
- Displays the date/time ..... pg. 10, 34, 36
- Appears when the focus is adjusted manually ..... pg. 29, 30
- Appears when the flash is ready.
  - A number appears next to the indication after adjusting the brightness of the flash ..... pg. 25
- Displays the sound mode ..... pg. 35, 36
- Displays the Blank Search mode ..... pg. 15
- Displays the tape speed ..... pg. 10
- Appears while a tape is running
  - : Playback
  - : Fast-Forward/Shuttle Search
  - : Rewind/Shuttle Search
  - : Pause
  - : Forward Frame-By-Frame Playback/Slow-Motion
  - : Reverse Frame-By-Frame Playback/Slow-Motion
  - : Audio Dubbing
  - : Audio Dubbing Pause
- • BRIGHT : Displays the brightness of the LCD monitor ..... pg. 12
- VOLUME : Displays the speaker volume ..... pg. 14
  - The level indicator moves.
- Displays the operation mode ..... pg. 19
- Displays the folder and file number ..... pg. 19

## WARNING INDICATIONS

### (high) → → → (exhausted)

Displays the battery remaining power level. As the battery power comes close to nil, the battery indicator  blinks (battery power warning). When the battery power is exhausted, power turns off automatically.



Appears when no tape is loaded. (📖 pg. 9)

### CHECK TAPE'S ERASE PROTECTION TAB

Appears when the erase protection tab is set to "SAVE" while the Power Switch **12** is set to "A" or "M" and the VIDEO/MEMORY Switch **25** is set to "VIDEO". (📖 pg. 9)

### ⊗ HEAD CLEANING REQUIRED USE CLEANING CASSETTE

Appears if dirt is detected on the heads during recording or playback. Use an optional cleaning cassette. (📖 pg. 49)

### 💧 CONDENSATION, OPERATION PAUSED PLEASE WAIT

Appears if condensation occurs. When this indication is displayed, wait more than 1 hour until condensation disappears.

### TAPE!

Appears if a tape is not loaded when the Recording Start/Stop Button **11** or SNAPSHOT Button **9** is pressed while the Power Switch **12** is set to "A" or "M" and the VIDEO/MEMORY Switch **25** is set to "VIDEO".

### TAPE END

Appears when the tape ends during recording or playback.

### SET DATE/TIME!

- Appears when the date/time is not set. (📖 pg. 10)
- Appears when the built-in clock (lithium) battery is discharged and the previously set date/time is erased. (📖 pg. 49)

### LENS CAP

Appears for 5 seconds after power is turned on if the lens cap is attached.

### A. DUB ERROR!

Appears if Audio Dubbing is attempted on a blank portion of a tape. (📖 pg. 40)

### A. DUB ERROR!

<CANNOT DUB ON A LP RECORDED TAPE>  
<CANNOT DUB ON A 16BIT RECORDING>  
<CHECK TAPE'S ERASE PROTECTION TAB>

- Appears if Audio Dubbing is attempted on a tape recorded in the LP mode.
- Appears if Audio Dubbing is attempted on a tape recorded in 16-bit audio.
- Appears if A. DUB **62** on the remote control is pressed when the erase protection tab is set to "SAVE". (📖 pg. 40)

### INSERT ERROR!

Appears if Insert Editing is attempted on a blank portion of a tape. (📖 pg. 40)

### INSERT ERROR!

<CANNOT EDIT ON A LP RECORDED TAPE>  
<CHECK TAPE'S ERASE PROTECTION TAB>

- Appears if Insert Editing is attempted on a tape recorded in the LP mode.
- Appears if INSERT **63** on the remote control is pressed when the erase protection tab is set to "SAVE". (📖 pg. 40)

### MEMORY IS FULL

Appears when the memory card's memory is full and shooting is not possible.

### COPYING FAILED

Appears if dubbing of copyguarded signals is attempted while this camcorder is being used as a recorder.

### COPYING FAILED

<MEMORY CARD!>  
<MEMORY IS FULL>  
<PLEASE FORMAT>

Appears in the following cases when dubbing from a tape to a memory card:

- when no memory card is loaded.
- when the memory card's memory is full.
- when the memory card is not formatted.

### MEMORY CARD!

Appears if there is no memory card loaded when you attempt to record on a memory card or access data on a memory card.

### PLEASE FORMAT

Appears when there is a problem with a memory card and its memory is corrupt, or it has not been initialized. Initialize the memory card. (📖 pg. 24)

### NO IMAGES STORED

Appears if there are no image files stored on the memory card when you attempt memory card playback.

### NO E-MAIL CLIP STORED

Appears if there are no video clip files stored on the memory card when you attempt memory card playback. (📖 pg. 22)



### **CARD ERROR!**

Appears when the camcorder does not recognize the loaded memory card. Remove the memory card once and insert it again. Repeat these procedures until no indication appears. If the indication still appears, the memory card is corrupted.

### **UNSUPPORTED FILE!**

Appears if a file in another format is selected.

### **CHECK CARD'S WRITE PROTECTION SWITCH**

- Appears when you attempt to record on a SD Memory Card with its write/erase protection tab in the "LOCK" position.
- Appears when you attempt Memory Card menu operation using a SD Memory Card with its write/erase protection tab in the "LOCK" position.

### **E01, E02 or E06 UNIT IN SAFEGUARD MODE REMOVE AND REATTACH BATTERY**

The error indications (E01, E02 or E06) show what type of malfunction has occurred. When an error indication appears, the camcorder turns off automatically. Remove the power supply (battery, etc.) and wait a few minutes for the indication to clear. When it does, you can resume using the camcorder. If the indication remains, consult your nearest JVC dealer.

### **E03 or E04 UNIT IN SAFEGUARD MODE EJECT AND REINSERT TAPE**

The error indications (E03 or E04) show what type of malfunction has occurred. When an error indication appears, the camcorder turns off automatically. Eject the cassette once and re-insert it, then check if the indication clears. When it does, you can resume using the camcorder. If the indication remains, consult your nearest JVC dealer.

<b>A</b>		<b>F</b>	
AC Adapter .....	pg. 7, 8	Fade-In/Out .....	pg. 28
Analog Input .....	pg. 35, 37	Fast-Forward The Tape .....	pg. 14
Animation .....	pg. 33	5-Second Recording Mode .....	pg. 26
Audio Dubbing .....	pg. 40	Flash .....	pg. 25
Auto Date .....	pg. 34	Frame-By-Frame Playback .....	pg. 39
Auto Focus .....	pg. 29	<b>G</b>	
Auto Playback .....	pg. 19	Gain Up .....	pg. 33
Auto Shut off .....	pg. 12, 15, 17	Grip Adjustment .....	pg. 8
<b>B</b>		<b>I</b>	
Backlight Compensation .....	pg. 30	Icons .....	pg. 32 – 36
Battery Low .....	pg. 56	Index Playback .....	pg. 19
Battery Pack .....	pg. 7, 8, 48	Index Screen .....	pg. 19
Beep .....	pg. 34	Initialize A Memory Card .....	pg. 24
Blank Search .....	pg. 15	Insert Editing .....	pg. 40
Brighten The LCD Monitor .....	pg. 12	Iris .....	pg. 31
<b>C</b>		Iris Lock .....	pg. 31
Cautions .....	pg. 48, 49	<b>J</b>	
Channels (Left/Right) .....	pg. 36	Journalistic Shooting .....	pg. 13
Charge The Battery Pack .....	pg. 7	<b>L</b>	
Cinema .....	pg. 33	LCD monitor/Viewfinder Indications .....	pg. 54 – 57
Classic Film .....	pg. 27	Load A Tape .....	pg. 9
Clean The Camcorder .....	pg. 50	<b>M</b>	
Connections .....	pg. 7, 16, 37, 38, 42, 44	Making New Folder .....	pg. 24
<b>D</b>		Maintenance .....	pg. 50
Darken The LCD Monitor .....	pg. 12	Manual Focus .....	pg. 30
Date/Time Display .....	pg. 34 – 36	Memory Card .....	pg. 11, 48
Date/Time Settings .....	pg. 10	Menu Screen, CAMERA .....	pg. 32, 33
Deleting Files .....	pg. 20	Menu Screen, CAMERA DISPLAY .....	pg. 34, 35
Demonstration Mode .....	pg. 6, 34	Menu Screen, DSC .....	pg. 11, 35
Digital Zoom .....	pg. 13, 32	Menu Screen, MANUAL .....	pg. 33
DIS (Digital Image Stabilizer) .....	pg. 33	Menu Screen, SYSTEM .....	pg. 34
Diopter Adjustment .....	pg. 8	Menu Screen, VIDEO .....	pg. 35
DPOF (Digital Print Order Format) .....	pg. 23, 24	Menu Screen, VIDEO DISPLAY .....	pg. 36
Dubbing .....	pg. 37, 38	Monotone .....	pg. 27
Dubbing Images from Tape to Memory Card .....	pg. 23	Motor Drive Mode .....	pg. 29
<b>E</b>		MultiMediaCard .....	pg. 11, 48
E-Mail Clip Recording .....	pg. 22	<b>N</b>	
Erase Protection .....	pg. 9	NAVIGATION function .....	pg. 21, 22
Exposure Control .....	pg. 30	Night-Alive .....	pg. 27
		Number of Starable Images .....	pg. 18

**P**

Picture Quality/Image Size .....	pg. 11
Picture Wipe/Dissolve .....	pg. 43
Playback Special Effects .....	pg. 39
Playback Zoom .....	pg. 39
Power-Linked Operation .....	pg. 13
Power Switch Position .....	pg. 13
Program AE With Special Effects .....	pg. 27
Protecting Files .....	pg. 20
Provided Accessories .....	pg. 5

**R**

Random Assemble Editing .....	pg. 41 – 43
Record-Standby .....	pg. 12
Recording Mode .....	pg. 10
Red-Eye Reduction .....	pg. 25
Remote Control .....	pg. 5, 39
Reset .....	pg. 34
Rewind The Tape .....	pg. 14

**S**

SD Memory Card .....	pg. 11, 48
Self-Recording .....	pg. 13
Self-Timer .....	pg. 26
Sepia .....	pg. 27
Set Remote Control/VCR Code .....	pg. 41
Shuttle Search .....	pg. 14
Shutter Speed .....	pg. 27
Slow-Motion Playback .....	pg. 14, 39
Snapshot .....	pg. 17, 29
Snapshot Mode .....	pg. 29
Snow .....	pg. 27
Sound Mode .....	pg. 32, 35, 36
Speaker Volume .....	pg. 14
Specifications .....	pg. 51
Sports .....	pg. 27
Spotlight .....	pg. 27
Squeeze .....	pg. 33
Still Playback .....	pg. 14
Strobe .....	pg. 27

**T**

Tally .....	pg. 34
Tele Macro .....	pg. 33
Time Code .....	pg. 14, 35, 36
Tripod Mounting .....	pg. 9
Troubleshooting .....	pg. 45 – 47
Twilight .....	pg. 27

**U**

Unload A Tape .....	pg. 9
---------------------	-------

**V**

VIDEO/MEMORY Switch Position .....	pg. 13
Viewing File Information .....	pg. 19

**W**

Warning Indications .....	pg. 56, 57
White Balance .....	pg. 31
Wide Mode .....	pg. 33
Wind Cut .....	pg. 33
Wipe In/Out .....	pg. 28

**Z**

Zooming .....	pg. 13
---------------	--------

